

Enhance your fluid automation  
project certainty



**ASCO™ Integrated Solutions**

Save time and money on resources so you can focus on the areas where you add value



## Solving your complex fluid automation challenges doesn't get any easier with less resources and shorter timescales

As manufacturers look to get a faster return on their investments, you are under increasing pressure to complete projects within shorter timeframes. The availability of experienced engineers is often limited, but budget constraints prevent you from bringing in additional resources. Increasingly complex pneumatic challenges require you to work with multiple suppliers, which can add complexity and time to the project. It also makes keeping control of costs more difficult, especially if minor components are overlooked or compatibility issues require redesigns. To ensure your project meets these challenges, you need to simplify your fluid automation project.

“Companies are facing a shortage of resources and in-house expertise to solve the engineering problems appearing in the wake of complex innovations.”

– Aberdeen Group, June 2016



“38% of respondents report that the issues related to contracts, either between the partners, customers, suppliers etc, is one of the factors contributing to project complexity.”

– S.W. Azim, Understanding and Managing Project Complexity, University of Manchester, 2010



“Most capital projects are off schedule and over budget and generate a minimal return on investment. Capital projects are likely to become even more difficult to successfully complete as the projects themselves escalate in complexity.”

– Booz & Company, 2011





Not all companies are structured to design, build, and commission fluid automation solutions. What if you could free up engineering resources while minimizing procurement complexity and ensure projects are delivered on time and within budget?

## ASCO enclosure, panel and integrated assembly solutions help reduce fluid automation project complexity, cost and risk



ASCO enclosure, panel and integrated assembly solutions greatly simplify the challenge of designing and engineering your fluid automation system. By handing over the responsibility to an expert, this frees up valuable resources, reduces the number of suppliers and ensures that you keep a firm control of overall project deadlines and costs. Emerson's fully assembled, tested and certified enclosures and panels are easily installed and connected, helping to get production started sooner. These pre-packaged customized solutions free up purchasing, finance, logistics and order management resources, lowering procurement costs by 30%. Also, fixed price pneumatic systems prevent any surprises at the end of the project.



“We chose Emerson for their expert design and customization, along with their ability to go above and beyond our needs.”  
– Senior Project and Automation Manager, Crown-Baele, Belgium

## Meet tighter project timescales and start up sooner

A water treatment plant in Japan needed better control of pneumatic valves, but did not have the available time or manpower to design a suitable solution. Emerson engineered, constructed and certified five ready-to-install control enclosures, enabling the customer’s engineering resources to be focused on aspects where they could add value.

Project delivery ► p6

## Simplify procurement, reducing time and costs

A hydrocracker expansion project at a refinery in The Netherlands required redundant valve controls to improve safety. Emerson’s integrated project team provided control panels, including all products and engineering, which enabled the customer to reduce the number of suppliers, speed up the process and reduce time and labor costs.

Streamline procurement ► p8

## Keep firm control of project costs

A pharmaceutical manufacturing facility in the United States required a pneumatic solution fully integrated into its process automation system. By providing a future-proof turnkey enclosure, including manifolds and electronic marshalling technology, Emerson reduced complexity, time to install, commission and maintain, and ensured overall costs were kept low and within budget.

Fixed costs ► p10



## DELIVER your project on time and free up engineering resources

When implementing a capital project, it is essential to achieve a fast return on investment. This requirement affects the whole supply chain, with a tight time frame. Bringing in additional resources to support a fluid automation project can impact profitability and if that resource is not available, it may be a struggle to meet deadlines, potentially harming your reputation. Handing over the design and engineering of your pneumatic systems to Emerson can ensure you deliver your project on time. Emerson's ASCO enclosure, panel and integrated assembly solutions are supplied fully assembled, tested and certified. They are easily installed and connected, reducing the time your technicians need to spend on assembly, commissioning and testing. This frees up engineering resources to focus on other aspects of the project where they can add value.

### What's your challenge?



"Companies are facing a shortage of resources and in-house expertise to solve the engineering problems appearing in the wake of complex innovations."  
-Aberdeen Group, June 2016

### What's your opportunity?



By outsourcing the development and construction of 88 pre-assembled actuator control systems, used to control valves regulating the flow of oil across the Kirishi refinery, Russian oil and gas giant Surgutneftegas was able to realize significant cost and time savings.

## Expert support throughout the project



Comprehensive engineering services providing concept/design/validation.

► p18



Experienced technical experts who understand your industry and application.

► p18



Responsive global support by local field service.

► p18

## Ready-to-install systems minimize installation time

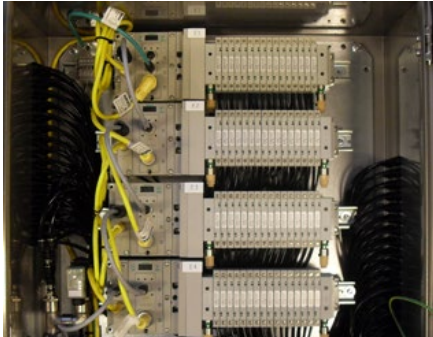

Engineered, pre-assembled, tested and fully certified solutions ready to install.

► p13



Modular designs for drop-in replacement and turnkey installation.

► p13

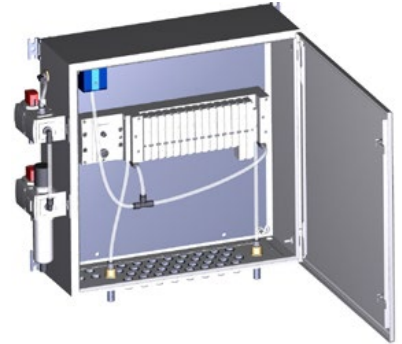

CAD drawing provided to confirm compliance with application requirements.

► p12

## Customized solutions to meet your application requirements



Fully integrated enclosure solutions for fast and simple connection.

► p12



Panel mounted pneumatic solutions for installation into a broad range of applications.

► p14



Integrated assemblies for simple on/off pneumatic actuator and solenoid assembly solutions.

► p16



For further information, visit [Emerson.com/en-us/automation/brands/asco/integrated-solutions](https://www.emerson.com/en-us/automation/brands/asco/integrated-solutions)





## STREAMLINE PROCUREMENT and minimize project risk

Automation projects are increasingly complex and you often need to work and maintain relationships with multiple suppliers to meet all your requirements. This expands procurement and project management, with multiple quotations, orders and additional time required for expediting to ensure a project remains on track. By selecting an ASCO enclosure, panel or integrated assembly solution, this enables you to place one purchase order with one supplier and receive one shipment. Emerson can help you free up purchasing, finance, logistics, and order management resources - reducing complexity and costs by 30%. A single point of accountability ensures your pneumatic products are supplied on time and work as expected.

### What's your challenge?



"38% of respondents report that the issues related to contracts, either between the partners, customers, suppliers etc, is one of the factors contributing to project complexity."

—S.W. Azim, Understanding and Managing Project Complexity, University of Manchester, 2010

### What's your opportunity?



A leading manufacturer of dairy equipment redesigned its automated milking station and required a turnkey air logic circuit assembly. This controlled pneumatic cylinders that operate entry and exit gates. Emerson designed, engineered, tested and shipped a turnkey integrated enclosure solution, dramatically reducing purchasing, installation and commissioning time.



## Work with a single supplier to reduce complexity

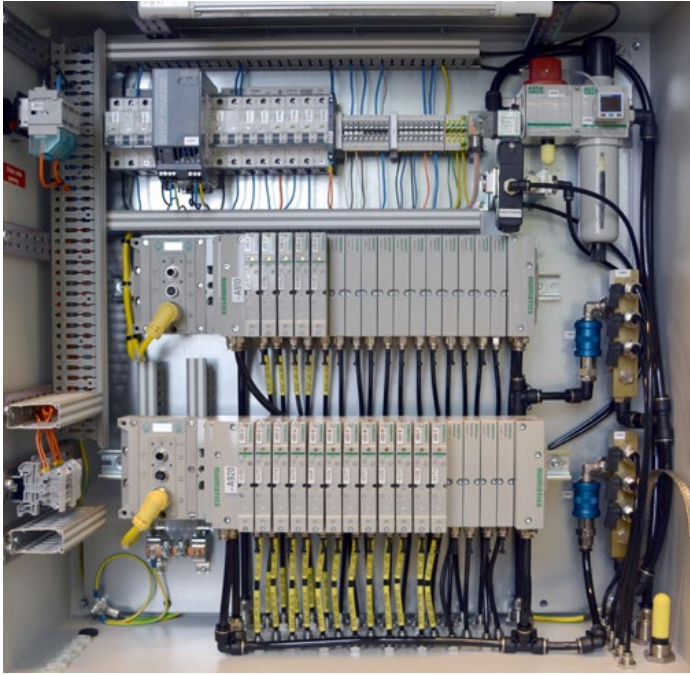

Broad product portfolio including ASCO Numatics directional control valves, fieldbus electronics with I/O technology, modular air preparation products, and accessories provides one-stop-shop.



Single request for quotation and order reduces procurement complexity. There is one point of accountability for making sure products are delivered on time and that they work as expected.

## Increase project assurance

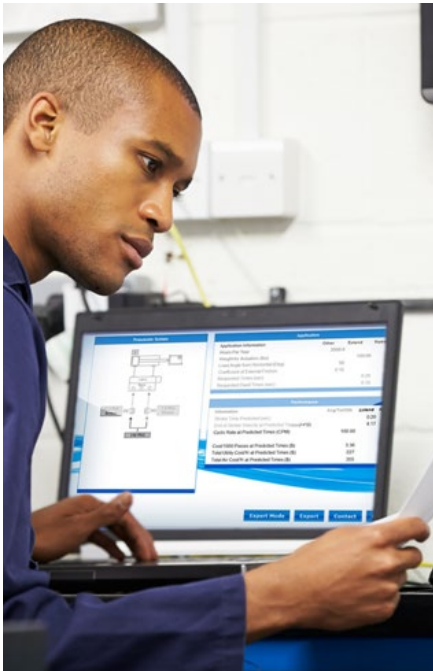

Numasizing® Online Engineering Tool to guide selection and optimization of pneumatic components.

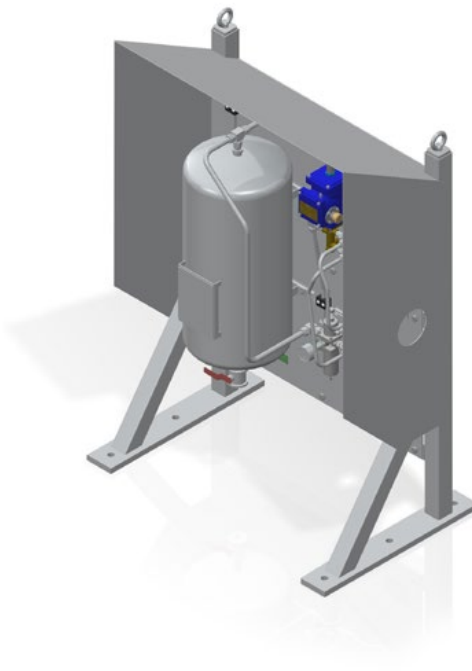

CAD drawing provided to confirm compliance with application requirements.  
▶ p12

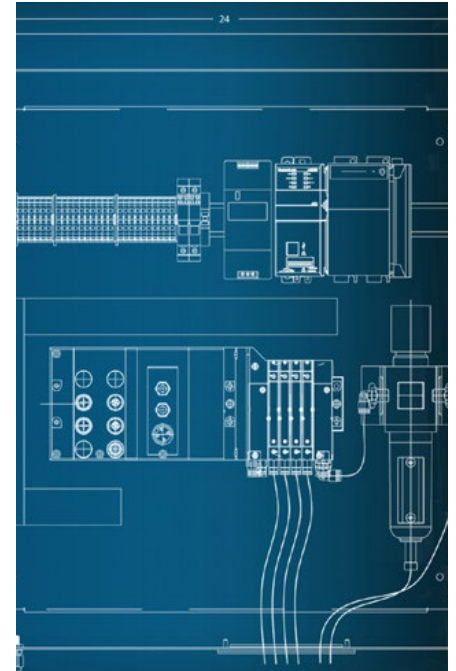

Build-to-blueprint construction to match your supplied schematics.  
▶ p19



For further information, visit [Emerson.com/en-us/automation/brands/asco/integrated-solutions](https://www.emerson.com/en-us/automation/brands/asco/integrated-solutions)





## Perform PRECISE BUDGET and return on investment calculations

When designing complex pneumatic systems, minor components can be overlooked and over the course of a large project can mount up. Overall project cost is not just about the purchase price of components. Labor used in designing, assembling and testing a system is often unseen. These costs can be estimated up-front and a contingency added. However, if components are missed they must be specified and purchased. If there are compatibility issues with any of the parts, a re-design may be required. These all add cost and can affect the project timeline. Emerson provides you with a fixed price for the pneumatic systems at the start of the project. This includes all costs for engineering, design, purchasing, invoicing, assembly, testing, and logistics. There are no surprises on completion of a project, which enables you to precisely calculate the return on investment and ensure you remain within budget.

### What's your challenge?



"Most capital projects are off schedule and over budget and generate a minimal return on investment. Capital projects are likely to become even more difficult to successfully complete as the projects themselves escalate in complexity.  
– Booz & Company, 2011



### What's your opportunity?

A large European manufacturer of consumer products upgraded its paper converting equipment. Emerson provided turnkey integrated enclosure solutions that significantly enhanced machine safety. These were delivered fully assembled, plumbed, wired and tested. Working with a single-source supplier saved time and cost. The five-month project was completed on schedule and on budget.

## No hidden costs provides budget assurance

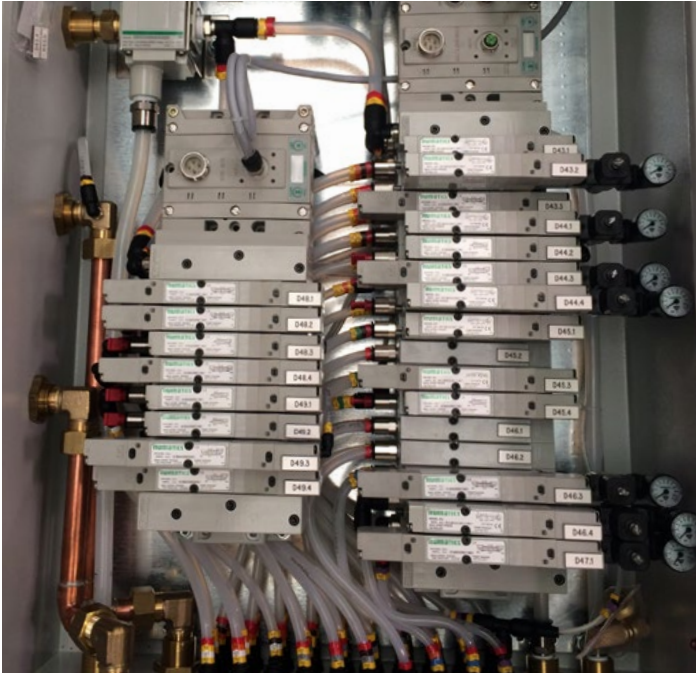

Fully costed systems are delivered tested, certified and ready to install.



Expert knowledge and industry expertise ensures delivered solution meets exact application requirement.

## Faster commissioning and lower lifecycle costs

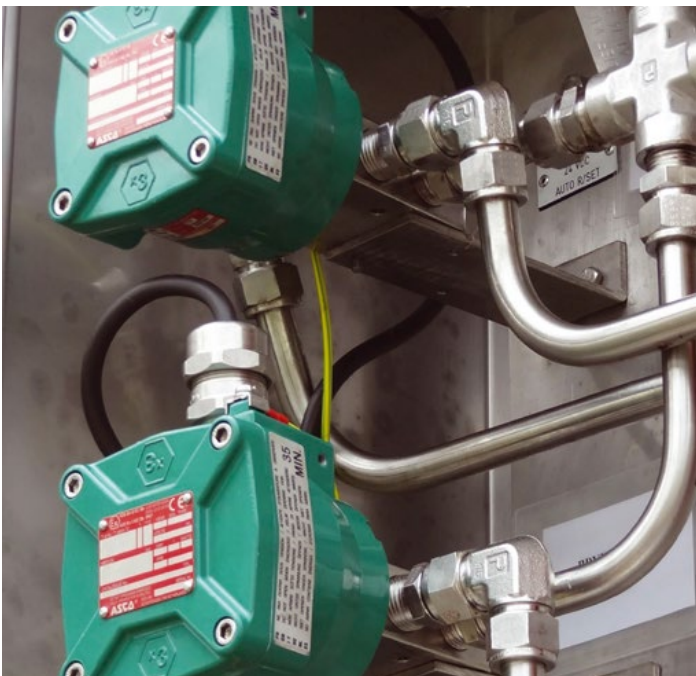

Highest quality parts and proven reliability supports reduced lifecycle costs.

► p14



Simple integration with existing systems enables fast commission, start-up and return on investment.



For further information, visit [Emerson.com/en-us/automation/brands/asco/integrated-solutions](https://www.emerson.com/en-us/automation/brands/asco/integrated-solutions)



## Enclosure solutions: customized, integrated turnkey solutions for your unique application

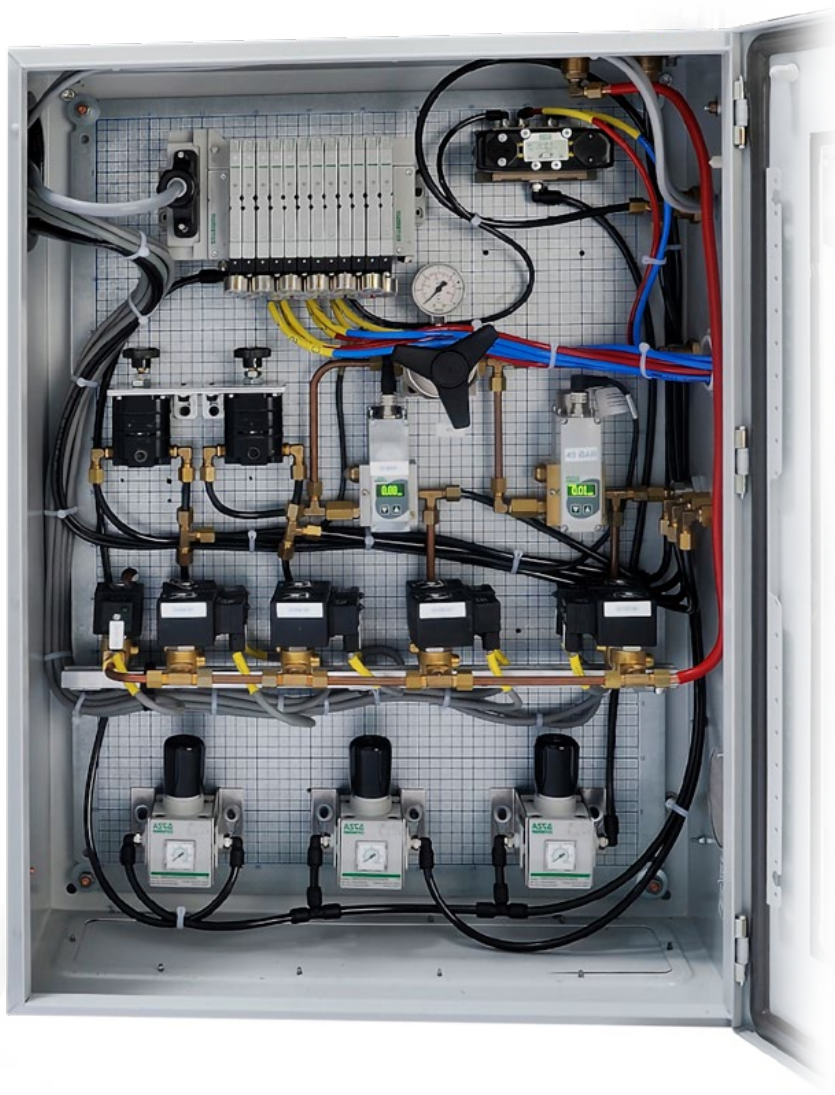

- Assembled, tested, certified and delivered as a turnkey solution
- Customized for your unique requirements
- Comprehensive engineering service includes build-to-blueprint construction to match your schematics with Auto CAD drawings created based on the application
- Value-added panel design, such as PLC integration, I/O integration, addition of power supply, terminal block, etc.

### Enclosure solutions overview

Emerson's integrated enclosure solutions greatly simplify your fluid automation set-up for process control and machine automation applications. They offer exceptional advantages for end users, original equipment manufacturers (OEMs) and engineering service providers. An optimized assembly of electrical and pneumatic components are specifically designed to meet the needs of your application. Already engineered, assembled, tested

and ready to install, these customized solutions maximize convenience, save costs and provide superior performance. Each solution incorporates best-in-class products, which can include ASCO Numatics directional control valves, fieldbus electronics, cylinders, proportional products, filters/regulators/lubricators, fluid control valves, and accessories.

## Reduce labor time, cost and disruptive work

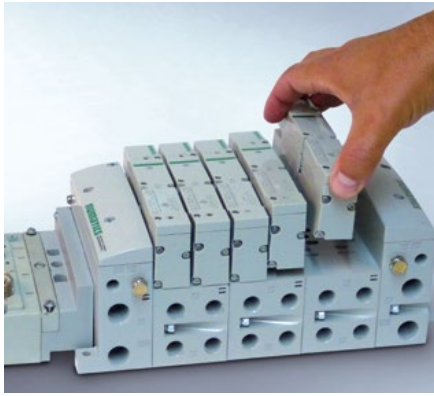

- Modular designs allow drop in replacement installation plus easy access to components and diagnostics

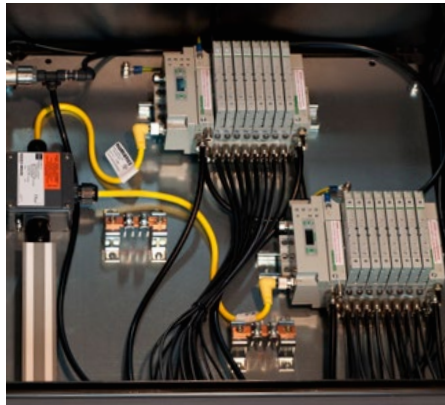

- Reduced interfaces, gateways, components, wiring and labor saves time and money

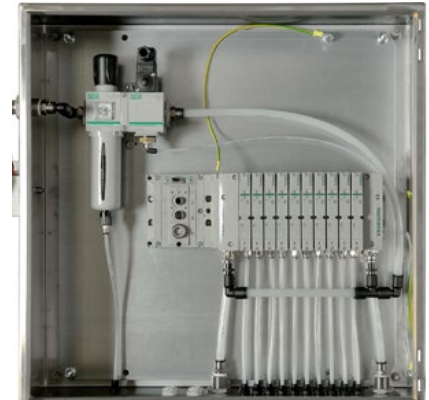

- Simplified designs reduce overall footprint and simplified architecture minimizes design, engineering and disruptive work

## Easier installation, integration and maintenance

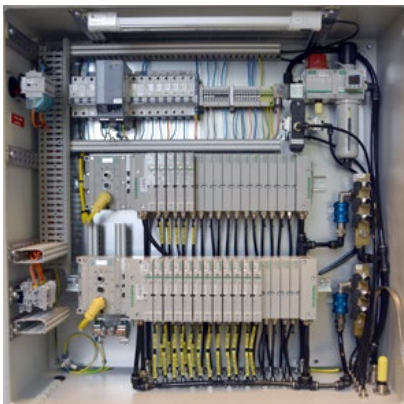

- Innovative products including ultra-high-flow directional control valves, fieldbus electronics, and modular air preparation products



- Simplified configuration and commissioning due to plain language diagnostics



- CHARMs node and electronic marshalling enables late I/O changes and reduces installation complexity by eliminating traditional cross-marshalling

## Meet your most challenging application requirements



- Pneumatic and electro-pneumatic control enclosure solutions for any architectural plant design



- Stainless steel, composite or customer specified panels ensure corrosion,- and damage-resistant installations in extreme temperatures



- Suitable for a wide range of applications within biomedical, pharmaceutical, food & beverage, petrochemical, water and wastewater, and factory automation

## Panel mount solutions: maximize pneumatic system performance with a minimal footprint



### Panel mount solutions overview

Emerson's ASCO panel mounted assemblies provide a bespoke pneumatic or electro-pneumatic control system solution for your fluid automation application. These provide an efficient space-saving way of connecting components to minimize system footprint and enable installation into a broad range of machines and applications. More easily accessible components also help to simplify diagnostics,

maintenance and replacement of parts. As with the enclosure assemblies, these customized turnkey solutions are fully designed, engineered, tested and certified by Emerson, making them ready to install and helping to save project time and costs. Best-in-class products help maximize performance, reduce maintenance and minimize lifecycle costs.

## Minimize your total lifecycle costs



- Pre-assembled panel mount solutions are fully tested and ready to install, reducing time and cost



- Reduced logistics costs and inventory holding

## Selected best-in-class products to maximize performance



- Integrated stainless steel redundant panel solution for increased reliability and safety

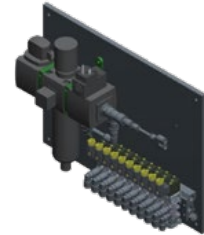

- Valve manifolds, solenoid valves, and air preparation products such as filter regulator and air reservoir for fail-safe operation

## Meet your industry standards and guidelines



- Solutions specifically designed and certified for oil and gas, water and waste water and general manufacturing.
- Certified solution for nuclear applications with volume tank for fail-safe operation
- SIL approved 2oo2 solutions

## Integrated assemblies: ready-to-install solutions that remove design and engineering time

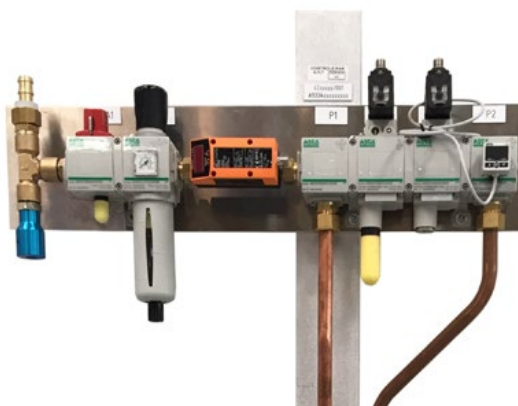

### Integrated assemblies overview

Integrated assemblies designed and engineered by Emerson help to provide greater fluid automation performance, reliability and value. Whether you require a simple on/off pneumatic actuator and solenoid valve assembly or a fully engineered linear actuator position system including emergency shutdown, Emerson has both the extended product

portfolio and engineering capability to create the solution that meets your application needs. Handing over the design and engineering of your pneumatic system frees up valuable resources and results in a fully assembled, tested and certified solution that is ready to install.



## Free up engineering time and reduce costs



- Fully assembled ready-to-install solutions create 30% savings in engineering, sourcing and installation



- Extensive automation product portfolio enables appropriate system to be designed without compromise for your application



- Modular air preparation assemblies, customized to the requirements of your application

## Meet the requirements of your unique application



- Cylinder solution with integrated solenoid valve for on/off functioning



- Cylinder solution with integrated solenoid valve and linear control function for open loop positioning



- Cylinder solution with integrated positioner. Includes emergency shutdown capabilities, control and closed loop positioning

## Meet industry standards and guidelines



Our solutions can be used in any application where control is required, from oil and gas to packaging, from life sciences to combustion. We design ready-to-install solutions, tested and certified to meet the requirements of your application.

## Solutions experience and services



Emerson fluid automation experts have extensive experience of providing solutions to a wide range of industries. Our project teams are skilled in understanding and accurately capturing and assessing your specific application requirements. We transform ideas into measurable outcomes and create solutions that maximize efficiencies and optimize your application. The company's global scale and responsive local teams help to reduce project timelines.

To support your automation project, we offer comprehensive engineering services, which can include design, building work, testing, drawings heating calculation, final inspection and on-site assistance.

## Testing



- Internal factory acceptance test
- In-situ testing

## Drawings

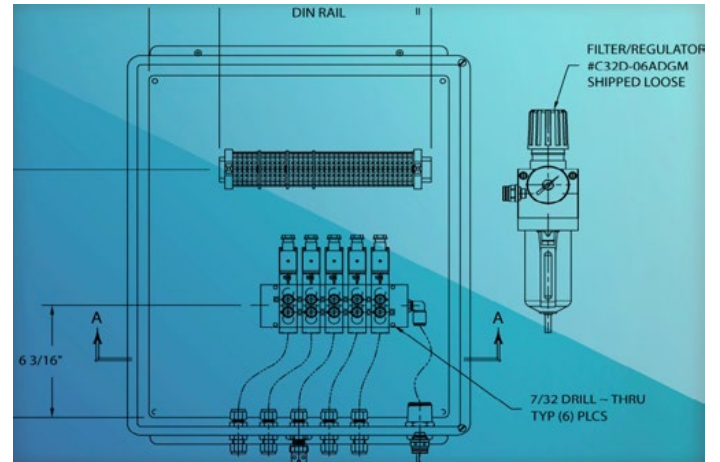

- As build drawings, loop drawings, pneumatic drawings, electrical drawings

## Additional services

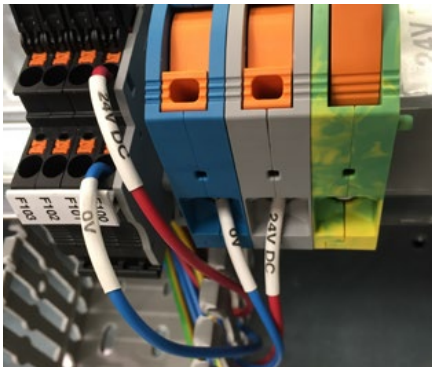

- All tubing and wiring marked for easy identification
- Electrical connections crimped



- Permanent labelling, including drawing inside enclosure for future identification and maintenance



- Our solutions are supplied with bill of material, pneumatic drawings, test and material certificates
- Securely packed and protected with ports plugged during transit

## Panel adapters

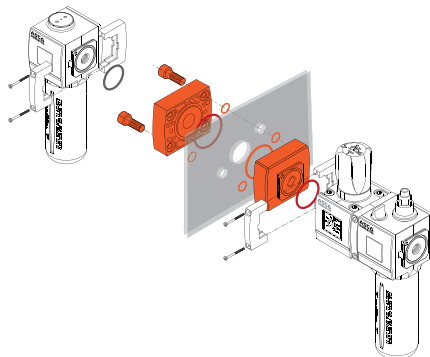

Panel adapters are available to enable air preparation products to be easily mounted inside or outside the enclosure. No additional piping is required and because the enclosure does not need to be opened to shut off the pneumatic air supply, this improves safety.



We also offer panel adapters to enable manifolds to be easily mounted inside or outside the enclosure:

- Stainless steel or aluminum adapter plate
- Environmentally protected components
- 8, 12, 16 or 24 stations
- UL, NEMA and IP66 certified

# Integrated solutions that reduce fluid automation project complexity, cost and risk







**ASCO™** Emerson's ASCO enclosure, panel and integrated assembly solutions are tailored to your unique application to ensure your fluid automation project maximizes its return on investment.

**Emerson Automation Solutions**  
**ASCO L.P. – United States**  
160 Park Avenue,  
Florham Park, NJ, 07932  
T +1 800-972-2726  
E info-valve@asco.com

**Emerson Automation Solutions**  
**ASCO SAS – France**  
53 Rue de la Beauce  
28111 Lucé  
T +33 (0)2 37 24 47 72  
E anf.serviceclients@emerson.com

**Emerson Automation Solutions**  
**ASCO ASIA – Singapore**  
Blk 4008, Ang Mo Kio Avenue 10  
#4-17/22, TECHplace 1  
Singapore 569625  
T +65 6556 1100  
E valvesales@emerson.com

-  [Emerson.com](https://www.emerson.com)
-  [Facebook.com/ascovalve](https://www.facebook.com/ascovalve)
-  [LinkedIn.com/company/Emerson-Automation-Solutions](https://www.linkedin.com/company/Emerson-Automation-Solutions)
-  [Twitter.com/ASCOValve](https://twitter.com/ASCOValve)

The Emerson logo is a trademark and service mark of Emerson Electric Co. Brand logotype are registered trademarks of one of the Emerson family of companies. All other marks are the property of their respective owners. © 2018 Emerson Electric Co. All rights reserved.



**CONSIDER IT SOLVED™**