

Bosch EXACT

Tightening Tools

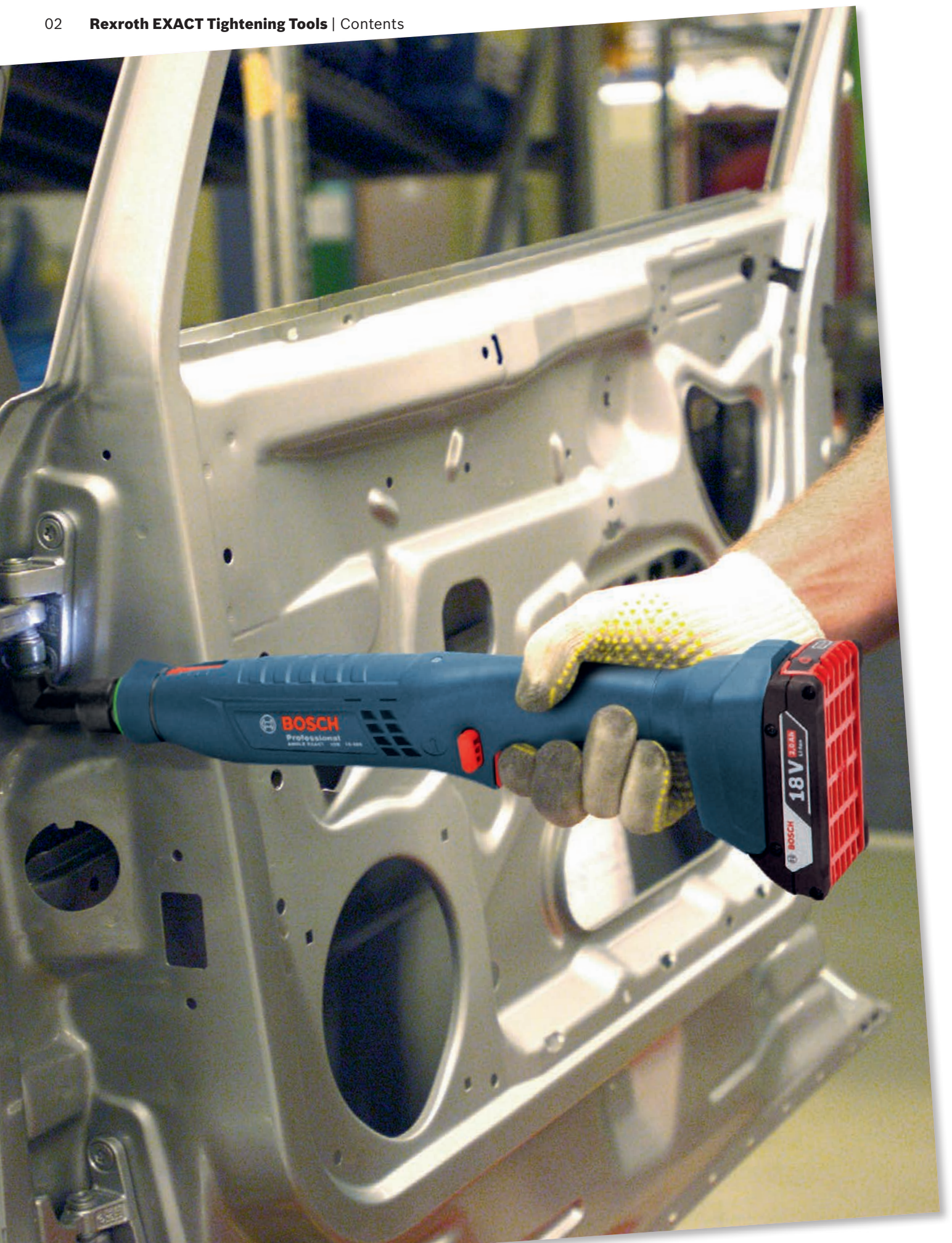

Cordless and electric screwdrivers
for industry



04 Screwdrivers for every tightening situation

06 Big in performance

07 Online support for production tools

08 Electric screwdrivers for industry

12 C-EXACT electric screwdrivers and
PUC-EXACT power supply and
power supply

14 EXACT 12

16 EXACT 12V

**18 EXACT ION
and ANGLE EXACT ION**

24 EXACT ION

26 EXACT ION WK

28 ANGLE EXACT ION

**30 Accessories and Dimensional
Drawings**

31 C-EXACT

33 EXACT 12V

36 EXACT ION and ANGLE EXACT ION

Screwdrivers for every tightening situation from Rexroth and Bosch

Rexroth is known as a provider of precise and robust tightening technology – tools, control systems and corresponding accessories – for demanding tightening tasks in various industries:

From the intelligent Nexo cordless Wi-Fi nutrunner and the ergonomic ErgoSpin hand-held nutrunner, to versatile tightening spindles and a fully automated tightening system.

Further information on these products can be found in the catalogs:

- ▶ Online catalog: www.boschrexroth.com/tightening
- ▶ PDF catalog: R999000049 in the Rexroth media directory www.boschrexroth.com/mediadirectory

KNOWN TIGHTENING TECHNOLOGY FROM REXROTH

A: Safety Critical

At least one independent direct measurement system
(e.g. separate transducer)



B: Function Critical

At least indirect measurement system
(e.g. motor current)



We now offer nutrunners for non-critical tightenings in your assembly as well. You do not only benefit from our experience as a partner for demanding tightening tasks - but also from the many years of experience of Bosch Powertools in the construction of powerful and reliable industrial nutrunners for non-critical tightening applications.

From now on you have one contact person for all topics concerning your tightening tasks.

TIGHTENING TECHNOLOGY FROM BOSCH

C: Non Critical (Quality related)

No measurement system required (e.g. clutch)



Big in performance, compact in size

The EXACT and ANGLE EXACT tools from Bosch are cordless shut-off screwdrivers for industry – offering the greatest accuracy, longevity and energy efficiency.

In assembly situations where cables or pneumatic hoses get in the way, the EXACT series enables you to optimise processes, build better products and reduce your costs.



- ▶ **Bright LED light** for illuminating the work area
- ▶ **Coloured marking rings** for easy identification
- ▶ **Right-hand/left-hand rotation change** with one hand
- ▶ **Repeat protection**
- ▶ **Low weight, balanced weight distribution** for better ergonomics
- ▶ **Industrial battery design** for longest lifetime
- ▶ **Torque setting** only with a special tool
- ▶ **Highest repeatability** due to Bosch clutch design
- ▶ **Easy service** due to plug connectors and common parts
- ▶ **Bosch SEC motor:** brushless motor technology
- ▶ **Visual and audible signals** provide information about battery status and screwdriving quality

EXACT

- ▶ Ergonomic
- ▶ EXtremely Light
- ▶ Accurate
- ▶ Cmk proven
- ▶ Tool

An overview with a single click: All production tools online

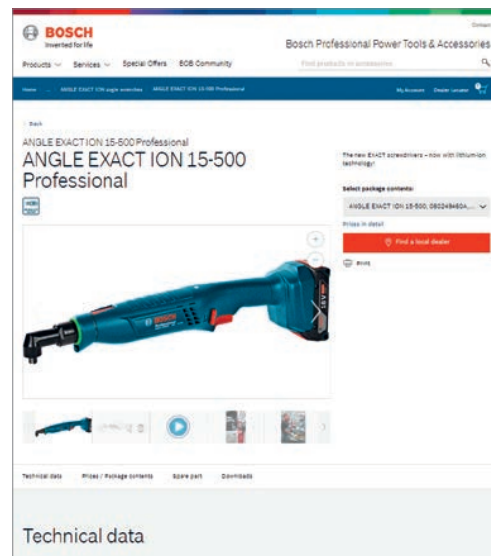
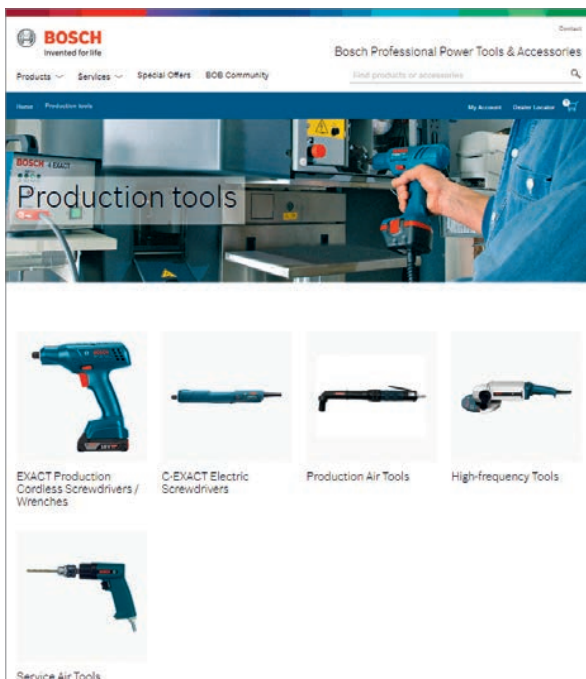

An extensive online catalogue including applications is available at www.boschproductiontools.com.

The tool selection is made easier by the ability to run comparisons between screwdrivers. For example, you can create a display of different tools and compare data such as power output or rpm.

Dimensional drawings, 3D data, homologation data, user manuals, pictures and exploded drawings can be downloaded directly from the internet.

A spare parts service informs users about which spare parts they need.

Furthermore, you will find the latest information about measurement data, innovations and new developments from Bosch Production Tools. You can quickly obtain all relevant information needed to select the correct tools for your production.

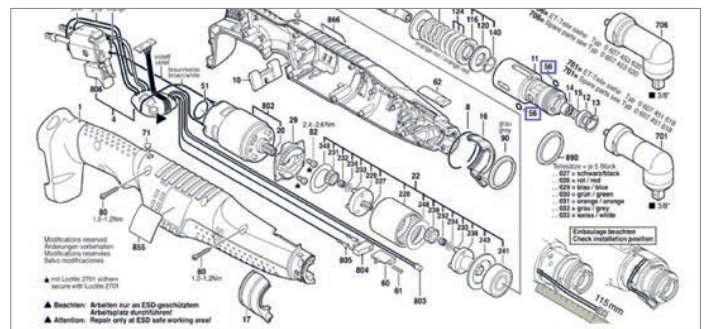

C-EXACT Production screwdrivers



Hopefully, you will not run out of screws

C-EXACT and PUC-EXACT. The production screwdriver system from Bosch. The new C-EXACT electric screwdrivers offer much more than just a robust housing. High accuracy and repeatability are guaranteed, even after driving 1 million* screws.

* according to Bosch endurance tests



Never lets you down even after 1 million screws

Robust, efficient and user-friendly

Low-voltage operation, brushless EC motor technology and key components from the EXACT cordless screwdriver series make the C-EXACT electric screwdrivers cost-effective tools with innovative performance features. When required, the clutch offers 15% more torque in left-hand rotation for loosening screws. The clutch is adjusted using a special tool. If the adjustment tool is stored in a location inaccessible to the user, the torque cannot be adjusted unintentionally. Colour marking rings enable quick identification of different screwdrivers in the assembly line.

Precise and stable under load

Whether assembling computer drives, electronics or precision mechanical equipment, the C-EXACT is the right choice when precision is what matters most.

Bosch quality testing for the C-EXACT family is extremely rigorous. In endurance testing, the C-EXACT tools must survive 1 million cycles (according to Bosch endurance tests) without failure before being released for production. During continuous operation, they must maintain an ISO 5393 standard Cmk value greater than 1.67 with a tolerance of $\pm 10\%$.



Our production tools are therefore among the most accurate on the planet.

C-EXACT electric screwdrivers

The C-EXACT screwdrivers are the first in a family of electric straight screwdrivers. They are equipped with a combination of great features and therefore set new standards for accuracy and longevity.

- ▶ Brushless EC motor technology
- ▶ Right-hand/left-hand rotation change with one hand
- ▶ ESD (ElectroStatic Discharge) compliant

PUC-EXACT power supplies

The C-EXACT electric screwdrivers use the PUC-EXACT power supply unit as a clean, silent energy source for the brushless EC motor.

The power supply unit contributes to a reduction in operating costs by efficiently supplying the tool with low voltage.

The electric screwdrivers in the C-EXACT series (electric screwdrivers with 3.5 Nm or 31 in/lbs of maximum torque) are available as a lever start or push start driver.

The PUC-EXACT power supply safely generates the low-voltage electricity needed for efficient operation.



ElectroStatic Discharge (ESD) compliant means the screwdriving system is ideal for use in the electronics and electrical industries.













C-EXACT, PUC-EXACT

Electric screwdrivers and power supply



- ▶ Bosch proves robustness and longevity by means of endurance tests with over one million work cycles
- ▶ Bosch SEC motor
- ▶ All models feature brushless EC motor technology
- ▶ High shut-off accuracy with very low tolerance
- ▶ Large torque range
- ▶ Visual and audible shut-off signals

	Part number	Torque, hard as per ISO 5393 (Nm)	Torque, soft as per ISO 5393 (Nm)
Electric screwdrivers C-EXACT 1			
	0 602 495 202	0.2 – 0.8	0.2 – 0.8
	0 602 495 207	0.2 – 0.8	0.2 – 0.8
Electric screwdrivers C-EXACT 2			
	0 602 495 203	0.5 – 2	0.5 – 2
	0 602 495 208	0.5 – 2	0.5 – 2
Electric screwdrivers C-EXACT 4			
	0 602 495 200	0.5 – 3.5	0.5 – 3.5
	0 602 495 205	0.5 – 3.5	0.5 – 3.5
Electric screwdrivers C-EXACT 6			
	0 602 495 210	1 – 6	1 – 6
	0 602 495 215	1 – 6	1 – 6
Electric screwdrivers C-EXACT 6			
	0 602 495 211	1 – 6	1 – 6
	0 602 495 216	1 – 6	1 – 6

- ▶ Robust and durable design
- ▶ Indicators for operational readiness and overload
- ▶ Available with connections for 1–3 screwdrivers simultaneously
- ▶ Temperature-controlled cooling fan

	Part number	Input voltage (V)	Input frequency (Hz)
Power supply PUC-EXACT 3	0 602 495 003	100 – 240 AC	50 – 60



Speed# (no load) (rpm)	Voltage (V)	Power (W)	Direction of rotation	Weight as per EPTA (kg)	Features and functions	Included accessories
1,000	36 DC	360	R/L	0.65	Lever start	Connecting cable 2.5 m Suspension hook Green colour ring
1,000	36 DC	360	R/L	0.65	Push start	
500	36 DC	360	R/L	0.65	Lever start	Connecting cable 2.5 m Suspension hook White colour ring
500	36 DC	360	R/L	0.65	Push start	
1,000	36 DC	360	R/L	0.65	Lever start	Connecting cable 2.5 m Suspension hook Grey colour ring
1,000	36 DC	360	R/L	0.65	Push start	
1,000	36 DC	360	R/L	0.65	Lever start	Connecting cable 2.5 m Suspension hook Black colour ring
1,000	36 DC	360	R/L	0.65	Push start	
500	36 DC	360	R/L	0.65	Lever start	
500	36 DC	360	R/L	0.65	Push start	
Power input (W)	Output voltage (V)	Features and functions			Included accessories	
400	36 DC	Power supply for up to three C-EXACT tools			Power cable 3 m	

EXACT 12V

Smaller, shorter, lighter – the cordless industrial screwdriver with perfect ergonomics.



Perfect ergonomics

- ▶ With a head length of 154 mm and a weight of 0.8 kg including 12 V/3.0 Ah rechargeable battery

Perfect process control

- ▶ With six different tightening steps, adjustable according to time, speed, direction and angle of rotation, as well as torque

Maximum service life and robustness

- ▶ Thanks to the brushless EC motor and high-quality, wear-free components



Flexible power system



- ▶ Compact 2.0 and 3.0 Ah rechargeable battery from the 12 V class
- ▶ The compact design is ideal for 12 V tools
- ▶ Optimised battery capacity makes it suitable for most 12 V applications
- ▶ 6.0 Ah battery with maximum runtime in Bosch's 12 V category
- ▶ Extremely high battery capacity delivers up to 300% more runtime than the 12 V 2.0 Ah Professional model
- ▶ Compact and with perfect balance between size and capacity for ultimate performance with 12 V power tools
- ▶ Compatible since 2005: all of our batteries are compatible with new and existing Bosch Professional tools in the same voltage class.



EXACT 12V



- ▶ Perfect ergonomics: With a head length of 154 mm and a weight of 0.8 kg including 12 V/3.0 Ah rechargeable battery
- ▶ Perfect process control: With six different screwdriving stages, adjustable according to time, speed, direction and angle of rotation, as well as torque
- ▶ Maximum service life and robustness: Thanks to the high-quality and wear-free components
- ▶ Brushless (EC) motor for 30 % more efficiency (compared to conventional DC motors) and extremely long service life
- ▶ LED ring light for optimally illuminating the work area, adjustable via a USB port
- ▶ Precision shut-off clutch with $C_{mk} > 1.67$ (in +/-10 % tolerance range according to ISO 5393)
- ▶ Visual and audible indication of screwdriving results and battery status, for the greatest process reliability
- ▶ Bosch Premium lithium-ion technology for long lifetime and runtime

	Part number	Torque, hard /soft as per ISO 5393 (Nm)	Speed (no-load)* (rpm)
	EXACT 12V-6-670 0 602 496 400	1.5 – 6	135 – 670
	EXACT 12V-3-1100 0 602 496 401	1 – 3	220 – 1,100
	EXACT 12V-2-670 0 602 496 402	0.5 – 2	135 – 670
			* Below 50 % speed the power may be lower

Bit holder	Battery specifications	Direction of rotation	Weight as per EPTA (kg) Including battery
1/4" quick-change chuck	12 V/3.0 Ah **	R/L	0.85
1/4" quick-change chuck	12 V/3.0 Ah **	R/L	0.85
1/4" quick-change chuck	12 V/3.0 Ah **	R/L	0.85
<p>** Rechargeable battery not in the items included</p>			

EXACT ION and ANGLE EXACT ION

With Lithium-Ion technology



Better than ever before!

With Bosch premium Lithium-Ion technology

The handy Bosch cordless shut-off screwdrivers in the EXACT range are now more powerful and efficient than ever before.

Enabling the highest repeatability, they are especially suitable for driving rows of screws and completing assembly applications with maximum performance whilst meeting very high quality demands. Thanks to Bosch Lithium-Ion battery technology, they deliver maximum power for high torques and speeds. They are also extremely resilient with minimal energy loss, so they additionally reduce your costs with their superior lifetime. Their low weight of only 1.3 kg (EXACT ION) also ensures impressively comfortable working in shift operations.



Bosch cordless technology Maximum efficiency hard-wired



**100% compatibility
within the 18 volt range**



**Bosch CoolPack for up to
100% more lifetime**

Multi-stage screwdriving process

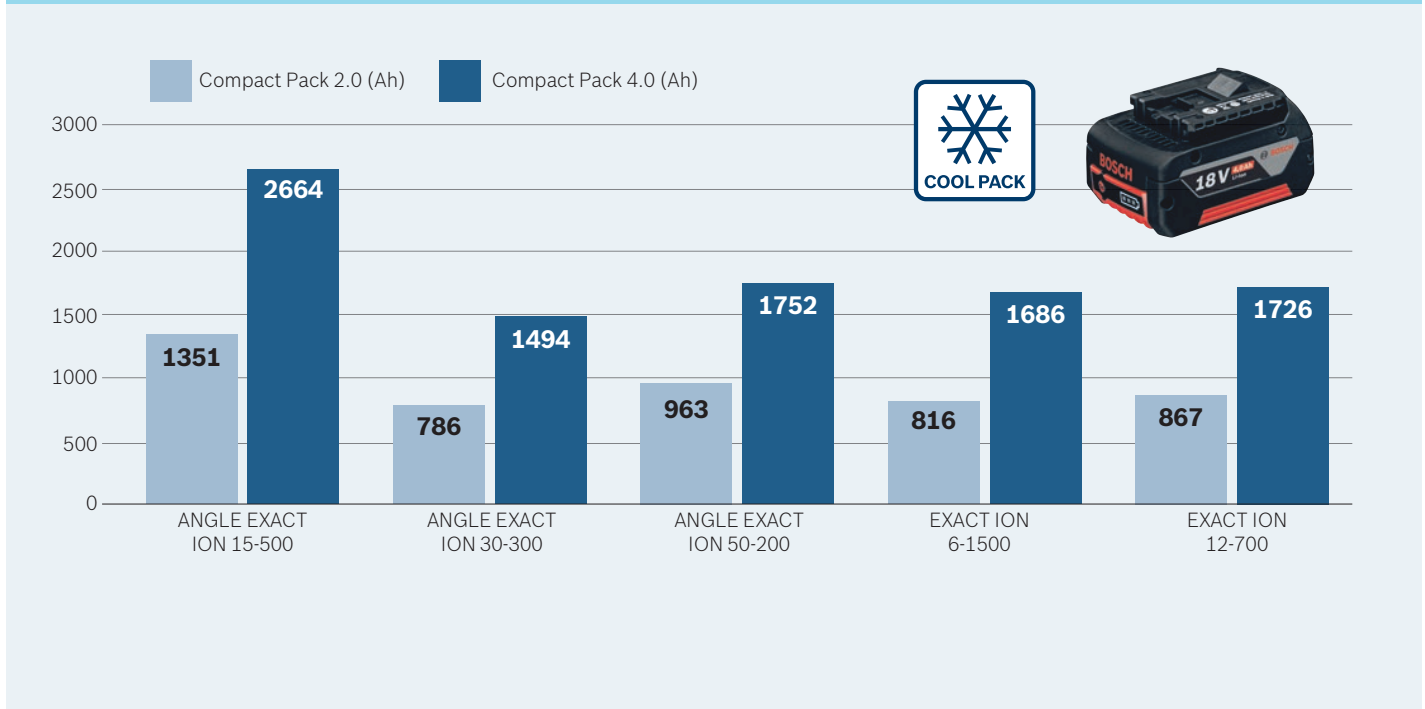

Results of endurance test 02/2013, at maximum torque and a medium-hard screwdriving application at 80° rotation angle, measured from a threshold torque of 50%, at screw size M8

Exceptional runtime and lifetime thanks to CoolPack

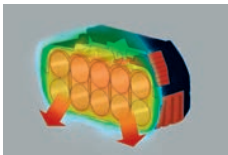

Red **CoolPack** housing made of heat-conductive material for up to 100% more lifetime compared to a Bosch battery without **CoolPack**. Bosch **CoolPack** ensures balanced warming and reduces heat build-up!

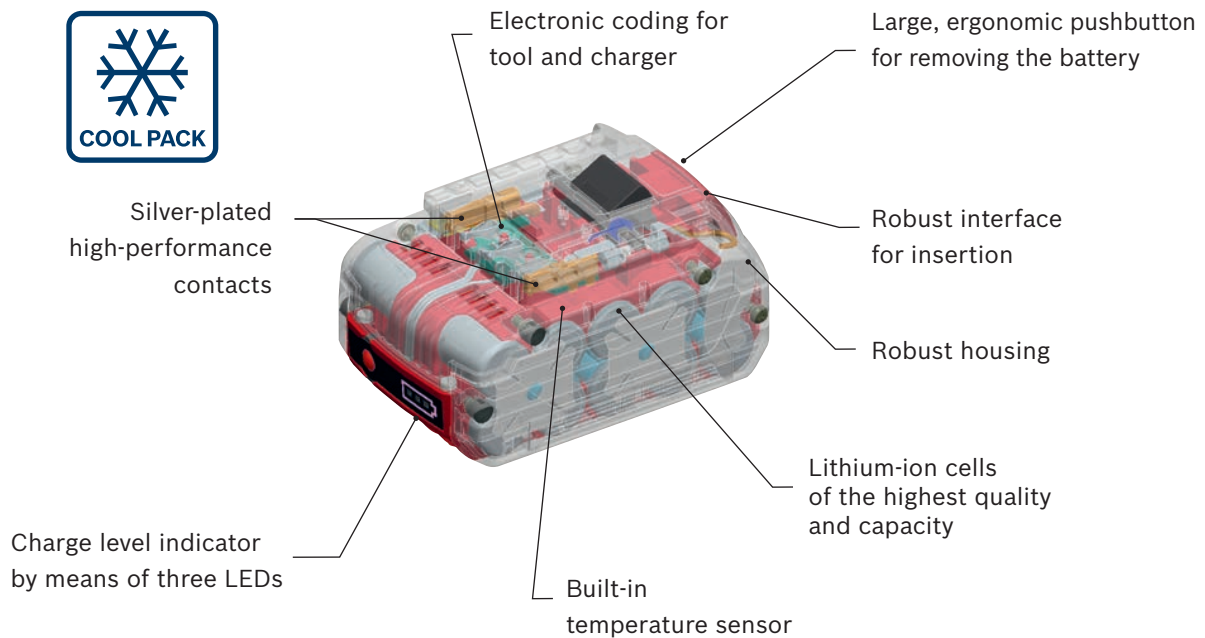

Our technology Your benefit

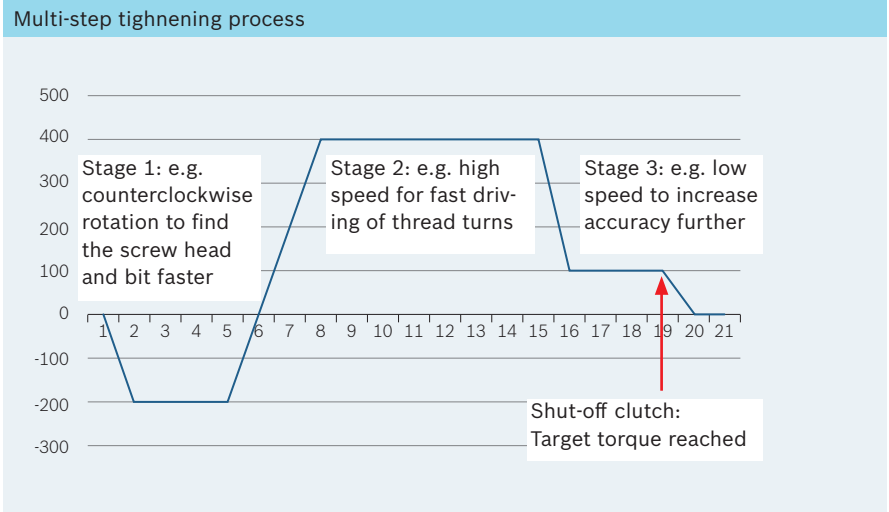

Stages 1, 2 (and 4) can be activated as required. Stage 3 is the standard stage in which the speed can be set between 50 and 100% as required.

Greater process reliability:

- ▶ Precision shut-off clutch with $C_{mk} > 1.67$ (at a tolerance of $\pm 10\%$ in accordance with ISO 5393)
- ▶ **NEW!** Multi-stage screwdriving process, adjustable to your individual application via USB interface

Greater efficiency:

- ▶ **NEW!** Bosch Premium lithium-ion technology for long lifetime and runtime
- ▶ **NEW!** Brushless (EC) motor for 30% more efficiency (compared to conventional DC motors) and extremely long lifetime

Greater comfort:

- ▶ **NEW!** New ergonomic design and lower weight for even more comfortable working

Lower costs:

- ▶ High rotational speeds and the screwdriving stages reduce production times and improve quality



- ▶ **Patented new interface**, to prevent mix-ups
- ▶ **Temperature monitoring and overload protection**, for extremely long lifetime
- ▶ **Double locking**, to prevent falling out
- ▶ **Charge level indicator**, to identify the charging state
- ▶ **Bosch high-performance battery cells**, with low energy loss, for the highest speeds and torques
- ▶ **Integrated cooling**, for extremely long lifetime

1/4" quick-release chuck,
for fast bit changes

Lighting LED,
for optimum illumination
of the work area

The proven Bosch **shut-off clutch**
is adjustable with a special tool,
for the highest accuracy

**New type of modular elec-
tronics,** for even easier main-
tenance

Angle head adjustable,
for even more
ergonomic use

Lighting LED adjustable,
for optimum illumination
of the work area

The safest 18 volt Li-Ion
battery pack, with extremely
long lifetime

Brushless motor:
Made by BOSCH,
for maintenance-free operation

**Visual and audible
indication of screw-
driving results and
battery status,** for the
greatest process reli-
ability

**New switch module and
new handle design,** for even
more ergonomic use







**USB interface for configur-
ing speed of screwdriving
stages,** adjustable to your
specific application



EXACT ION



- ▶ Precision shut-off clutch with $C_{mk} > 1.67$ (at a tolerance of $\pm 10\%$ in accordance with ISO 5393)
- ▶ Multi-stage screwdriving process, adjustable to your individual application via USB interface
- ▶ Bosch Premium lithium-ion technology for long lifetime and run-time
- ▶ Brushless (EC) motor for 30% more efficiency (compared to conventional DC motors) and extremely long lifetime
- ▶ New ergonomic design and lower weight for even more comfortable working
- ▶ High rotational speeds and the tightening steps reduce production times and improve quality

	Part number	Torque, hard as per ISO 5393 (Nm)	Speed (no load) (rpm)
EXACT ION 2-700 	0 602 494 400	0.5 – 2	70 – 700
EXACT ION 4-2000 	0 602 494 401	1 – 4	200 – 2,000
EXACT ION 6-1500 	0 602 494 402	1 – 6	150 – 1,500
EXACT ION 8-1100 	0 602 494 403	1.5 – 8	110 – 1,100
EXACT ION 12-700 	0 602 494 404	1.5 – 12	70 – 700
EXACT ION 12-450 	0 602 494 405	1.5 – 12	45 – 450





Bit holder	Battery specifications	Direction of rotation	Weight as per EPTA (kg)	Included accessories
1/4" quick-release chuck	18 V/2.0 Ah *	R/L	1.3 (including battery)	Light green colour ring Torque adjustment tool Suspension hook
1/4" quick-release chuck	18 V/2.0 Ah *	R/L	1.3 (including battery)	Grey colour ring Torque adjustment tool Suspension hook
1/4" quick-release chuck	18 V/2.0 Ah *	R/L	1.3 (including battery)	Black colour ring Torque adjustment tool Suspension hook
1/4" quick-release chuck	18 V/2.0 Ah *	R/L	1.3 (including battery)	Orange colour ring Torque adjustment tool Suspension hook
1/4" quick-release chuck	18 V/2.0 Ah *	R/L	1.3 (including battery)	Red colour ring Torque adjustment tool Suspension hook
1/4" quick-release chuck	18 V/2.0 Ah *	R/L	1.3 (including battery)	Black colour ring Torque adjustment tool Suspension hook

*
Battery not included
in scope of delivery
(see page <?>)

EXACT ION WK



- ▶ Precision shut-off clutch with Cmk > 1.67 (at a tolerance of $\pm 10\%$ in accordance with ISO 5393)
- ▶ Multi-stage screwdriving process, adjustable to your individual application via USB interface
- ▶ Bosch Premium lithium-ion technology for long lifetime and run-time
- ▶ Brushless (EC) motor for 30% more efficiency (compared to conventional DC motors) and extremely long lifetime
- ▶ New ergonomic design and lower weight for even more comfortable working
- ▶ High rotational speeds and the tightening steps reduce production times and improve quality

	Part number	Torque, hard /soft as per ISO 5393 (Nm)	Speed (no-load)* (rpm)
	EXACT ION 6-1500 WK 0 602 494 406	2 – 8	105 – 1,050
	EXACT ION 8-1100 WK 0 602 494 407	2 – 11	75 – 750
	EXACT ION 12-700 WK 0 602 494 408	2 – 16	50 – 500
	EXACT ION 12-450 WK 0 602 494 409	2 – 16	32 – 320

*
measured with
Bosch angle
screwdriving head

Bit holder	Battery specifications	Direction of rotation	Weight as per EPTA (kg)	Included accessories
Flange for angle head **	18 V/2.0 Ah ***	R/L	1.4 (including battery)	Black colour ring Torque adjustment tool Suspension hook
Flange for angle head **	18 V/2.0 Ah ***	R/L	1.4 (including battery)	Orange colour ring Torque adjustment tool Suspension hook
Flange for angle head **	18 V/2.0 Ah ***	R/L	1.4 (including battery)	Red colour ring Torque adjustment tool Suspension hook
Flange for angle head **	18 V/2.0 Ah ***	R/L	1.4 (including battery)	Light blue colour ring Torque adjustment tool Suspension hook







**
Angle head not included in scope of delivery (see page <?>)

Battery not included in scope of delivery (see page <?>)

ANGLE EXACT ION



- ▶ Precision shut-off clutch with Cmk > 1.67 (at a tolerance of $\pm 10\%$ in accordance with ISO 5393)
- ▶ Multi-stage screwdriving process, adjustable to your individual application via USB interface
- ▶ Bosch Premium Lithium-Ion technology for long lifetime and run-time
- ▶ Brushless (EC) motor for 30% more efficiency (compared to conventional DC motors) and extremely long lifetime
- ▶ New ergonomic design and lower weight for even more comfortable working
- ▶ High rotational speeds and the tightening steps reduce production times and improve quality

	Part number	Torque, hard/soft as per ISO 5393 (Nm)	Speed (no-load) (rpm)
ANGLE EXACT ION 3-500 	0 602 494 608	0.7 – 3	50 – 520
ANGLE EXACT ION 8-1100 	0 602 494 600	2 – 8	110 – 1,100
ANGLE EXACT ION 15-500 	0 602 494 601	2 – 15	50 – 520
	0 602 494 60A	2 – 15	50 – 520
ANGLE EXACT ION 23-380 	0 602 494 602	10 – 23	38 – 380
ANGLE EXACT ION 30-290 	0 602 494 607	10 – 30	29 – 290
	0 602 494 60B	10 – 30	29 – 290
ANGLE EXACT ION 30-300 	0 602 494 603	10 – 30	30 – 300
ANGLE EXACT ION 40-220 	0 602 494 604	15 – 40	22 – 220
ANGLE EXACT ION 50-210 	0 602 494 605	15 – 50	21 – 180
ANGLE EXACT ION 60-120 	0 602 494 606	15 – 60	12 – 120

Bit holder	Battery specifications	Direction of rotation	Weight as per EPTA (kg)	Included accessories
Flange for angle head *	18 V/2.0 Ah **	R/L	1.7 (including battery)	Light green colour ring Torque adjustment tool Suspension hook
Flange for angle head *	18 V/2.0 Ah **	R/L	1.7 (including battery)	Light blue colour ring Torque adjustment tool Suspension hoo
Flange for angle head *	18 V/2.0 Ah **	R/L	1.7 (including battery)	Light green colour ring Torque adjustment tool Suspension hook
3/8" square	18 V/2.0 Ah **	R/L	1.7 (including battery)	Light green colour ring Torque adjustment tool Suspension hook Angle screwdriving head 3/8"
Flange for angle head *	18 V/2.0 Ah **	R/L	2.2 (including battery)	White colour ring Torque adjustment tool Suspension hook
Flange for angle head *	18 V/2.0 Ah **	R/L	2.2 (including battery)	Grey colour ring Torque adjustment tool Suspension hook
3/8" square	18 V/2.0 Ah **	R/L	2.2 (including battery)	Grey colour ring Torque adjustment tool Suspension hook Angle screwdriving head 3/8"
3/8" square	18 V/2.0 Ah **	R/L	2.4 (including battery)	Light grey colour ring Torque adjustment tool Suspension hook Angle screwdriving head 3/8"
3/8" square	18 V/2.0 Ah **	R/L	2.4 (including battery)	Orange colour ring Torque adjustment tool Suspension hook Angle screwdriving head 3/8"
3/8" square	18 V/2.0 Ah **	R/L	2.4 (including battery)	Red colour ring Torque adjustment tool Suspension hook Angle screwdriving head 3/8"
3/8" square	18 V/2.0 Ah **	R/L	2.4 (including battery)	Black colour ring Torque adjustment tool Suspension hook Angle screwdriving head 3/8"









* Angle head not included in scope of delivery (see page <?>)
** Battery not included in scope of delivery (see page <?>)

Accessories

EXACT original accessories



Colour rings, protective cap for C-EXACT

Accessories		Part number	Quantity	
Colour rings For quick identification of the torque range Suitable for all C-EXACT straight screwdrivers and all EXACT cordless screwdrivers with centre grip		black	3 600 106 010	5
		red	3 600 106 011	5
		light blue	3 600 106 012	5
		light green	3 600 106 013	5
		orange	3 600 106 014	5
		grey	3 600 106 017	5
		white	3 600 106 019	5
		mixed (1 of each: black, red, blue, green, orange)	3 600 106 015	5
Protective cap For all 1/4" quick-release chucks Prevents damage to the workpiece			3 605 500 210	5

C-EXACT and PUC-EXACT Dimensional drawings

C-EXACT lever start

Dimensions in mm

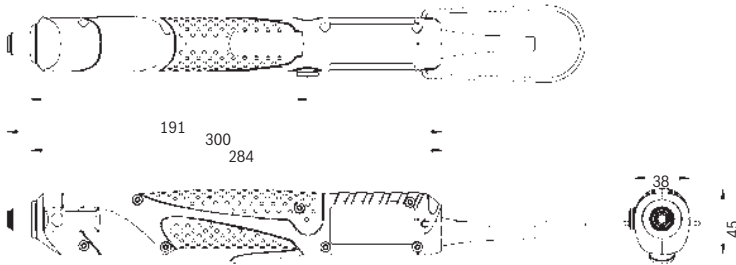

C-EXACT push start

Dimensions in mm

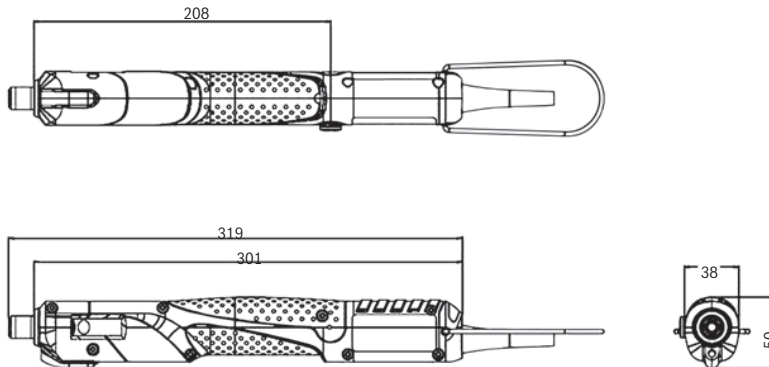



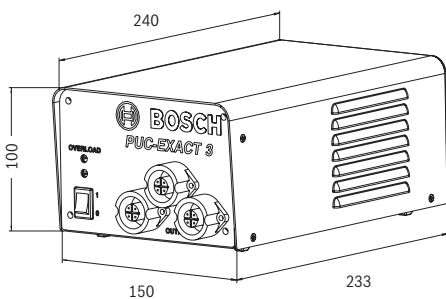

PUC-EXACT 3

Dimensions in mm









Battery packs and chargers for EXACT 12V







Battery pack Lithium-ion	Part number	Capacity (Ah)	Voltage (V)	Weight as per EPTA (kg)	Quantity
GBA 12 V/2.0 Ah Professional 	0 602 494 020	2.0	12	27 x 0.175	27
GBA 12 V/3.0 Ah Professional 	0 602 496 012	3.0	12	28 x 0.18	28
GBA 12 V/6.0 Ah Professional 	0 602 496 013	6.0	12	12 x 0.385	12
Battery pack protectors	Part number				Quantity
Transparent For the GBA 12V 6.0 Ah 	0 602 496 010				5
Prevent damage to the battery					
Lithium-Ion quick charger	Part number			Weight as per EPTA (kg)	Quantity
GAL 12V-40 Fully charges the GBA 12V/3.0 Ah in 50 minutes and the GBA 12V/6.0 Ah in 95 minutes.	0 602 494 007			18 x 0.45	16
	0 602 496 014			18 x 0.45	16

Coloured covers, RFID attachment, protectors for EXACT 12V



Accessories			Part number	Quantity
EXACT 12V and ANGLE EXACT 12V				
Covers coloured For quickly identifying the torque range and with extra large bonding surface. Suitable for every EXACT 12V and ANGLE EXACT 12V		black	0 602 497 008	5
		blue	0 602 497 004	5
		red	0 602 497 005	5
		green	0 602 497 006	5
		yellow	0 602 497 007	5
RFID attachment Black cover with NFC chip for wireless screwdriver identification. Suitable for every EXACT 12V and ANGLE EXACT 12V		Black (Chip: NXP NTAG 216 – 924 bytes)	0 602 496 011	5

Accessories			Part number	Quantity
EXACT 12V				
Protectors Prevent damage to the workpiece Suitable for all EXACT ION centre grip screwdrivers Will not block motor air vents		transparent	0 602 496 000	5
		blue	0 602 496 001	5
		red	0 602 496 002	5
		green	0 602 496 003	5
		yellow	0 602 496 004	5

EXACT 12V

Dimensional drawings





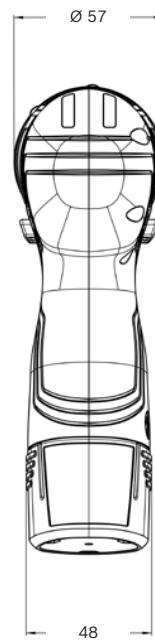
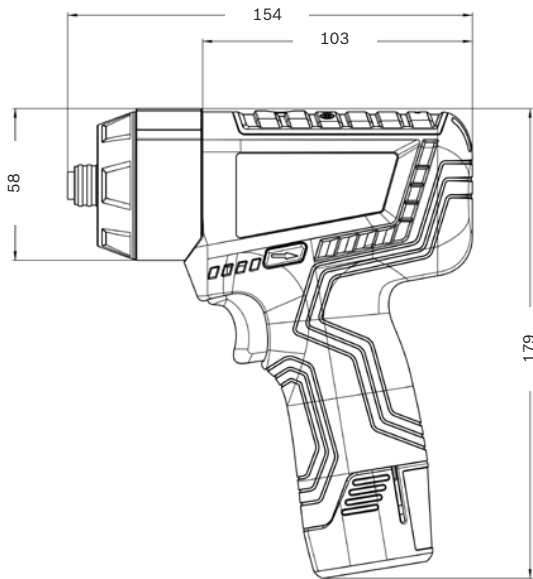

EXACT 12V



Dimensions in mm





Battery packs and chargers for EXACT ION and ANGLE EXACT ION



Battery pack Lithium-ion	Part number	Capacity (Ah)	Voltage (V)	Weight as per EPTA (kg)	Quantity
18 V/2.0 Ah 	0 602 494 002	2.0	18	12 x 0.35	12
18 V/4.0 Ah 	0 602 494 004	4.0	18	12 x 0.6	12
18 V/5.0 Ah 	0 602 494 003	5.0	18	12 x 0.6	12
ProCORE 18V/4.0Ah 	0 602 494 034	4.0	18	12 x 0.515	15









Battery pack protectors	Part number	Quantity
Transparent – for the 2.0 Ah Compact battery pack 	0 602 494 014	10
Transparent – for the 4.0 Ah Premium battery pack 	0 602 494 015	10

Prevent damage to the battery
Will not block the CoolPack housing
Suitable for 18 volt Li-Ion battery packs

Lithium-Ion quick charger	Part number	Voltage (V)	Weight as per EPTA (kg)	Quantity	
GAL 1880 CV 100% fully charges the Bosch Lithium-Ion batteries 18 V/2.0 Ah in 30 mins, 18 V/4.0 Ah in 35 mins and 18 V/5.0 Ah in 45 mins!		0 602 494 035	230	18 x 0.7	18
		0 602 494 036 (UK Plug)			
GAL 18V-40 100% fully charges the Bosch Lithium-Ion batteries 18V/2.0 Ah in 35 mins and 18V/5.0 Ah in 70 mins!		0 602 494 039	230	18 x 0.55	18
		0 602 494 040			















Angle heads for EXACT ION WK and ANGLE EXACT ION



Accessories		Part number	Max. torque (Nm)	Drive end	Weight (kg)	Quantity
Angle head For ANGLE EXACT ION 3-500, 8-1100, 15-500, 23-380 Gear ratio 1.4:1		0 607 453 617	27	1/4" square	0.2	1
		0 607 453 618	27	1/4" internal hex	0.2	1
		0 607 453 620	27	3/8" square	0.2	1
		0 607 453 630	27	1/4" QRC	0.2	1
HD angle head For ANGLE EXACT ION 30-290 (gear ratio 1.4:1)		0 607 451 618	35	3/8" square	0.22	1
Protective cap For angle heads 0 607 453 617, -618, -620, -630		3 605 500 171	-	-	-	1
0 607 451 618		3 605 500 175	-	-	-	1
Protective cap For ANGLE EXACT ION 30-300, 40-220, 50-210, 60-120		3 609 202 A29	-	-	-	1













Colour rings, protectors, protective cap for EXACT ION



Accessories		Part number	Quantity	
Colour rings For quick identification of the torque range Suitable for all EXACT ION centre grip screw-drivers		black	3 600 106 010	5
		red	3 600 106 011	5
		light blue	3 600 106 012	5
		light green	3 600 106 013	5
		orange	3 600 106 014	5
		grey	3 600 106 017	5
		white	3 600 106 019	5
		mixed (1 of each: black, red, blue, green, orange)	3 600 106 015	5
Protectors Prevent damage to the workpiece Suitable for all EXACT ION centre grip screw-drivers Will not block motor air vents		transparent	0 602 494 016	10
		red	0 602 494 018	10
		blue	0 602 494 017	10
		yellow	0 602 494 032	10
		green	0 602 494 019	10
Protective cap For all 1/4" quick-release chucks Prevents damage to the workpiece			3 605 500 210	5

Colour rings, protectors for ANGLE EXACT ION



Accessories		Part number	Quantity	
Colour rings For quick identification of the torque range Suitable for all ANGLE EXACT ION centre grip screwdrivers		black	3 600 106 027	5
		red	3 600 106 028	5
		light blue	3 600 106 029	5
		light green	3 600 106 030	5
		orange	3 600 106 031	5
		grey	3 600 106 032	5
		white	3 600 106 033	5
Protectors Prevent damage to the workpiece Suitable for all ANGLE EXACT ION centre grip screwdrivers Will not block motor air vents		transparent	0 602 494 010	10
		red	0 602 494 012	10
		blue	0 602 494 011	10
		yellow	0 602 494 033	10
		green	0 602 494 013	10

EXACT ION, -WK and ANGLE EXACT ION Dimensional drawings



EXACT ION Dimensions in mm

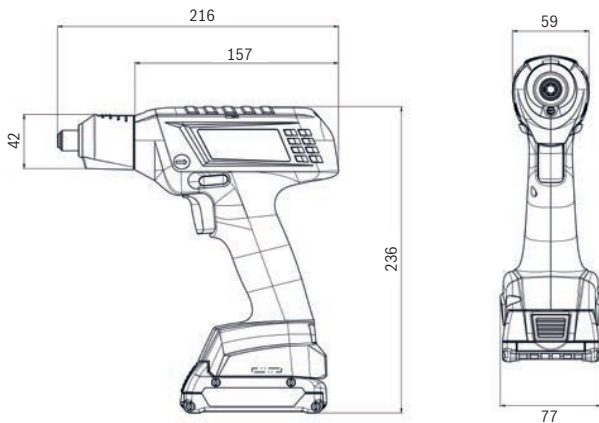

EXACT ION WK Dimensions in mm

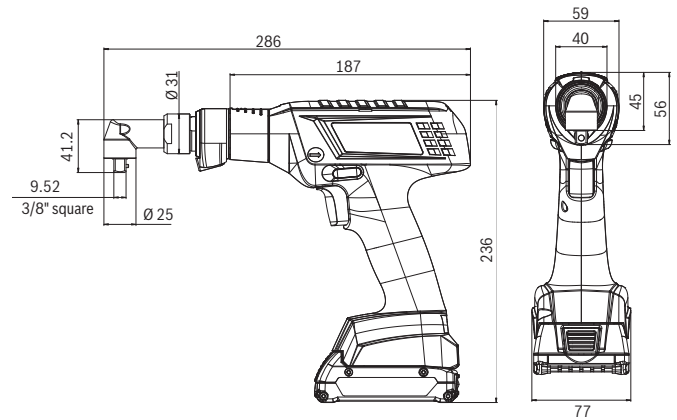

ANGLE EXACT ION model: 3-500, 8-1100 and 15-500 Dimensions in mm

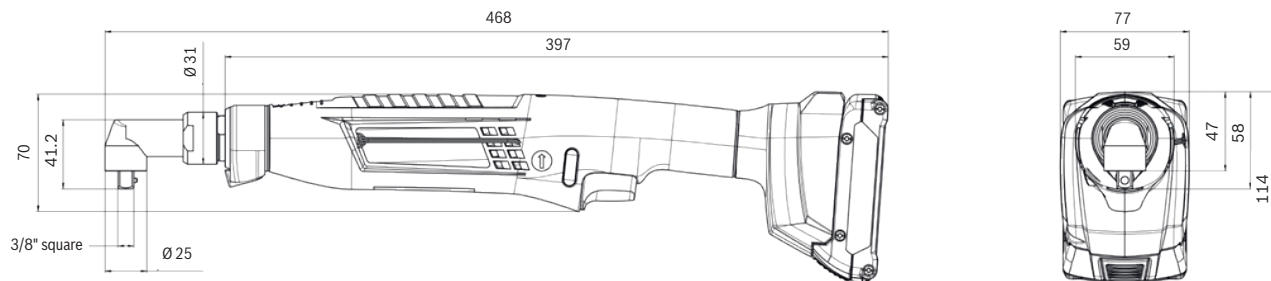

ANGLE EXACT ION model: 23-380 and 30-290

Dimensions in mm

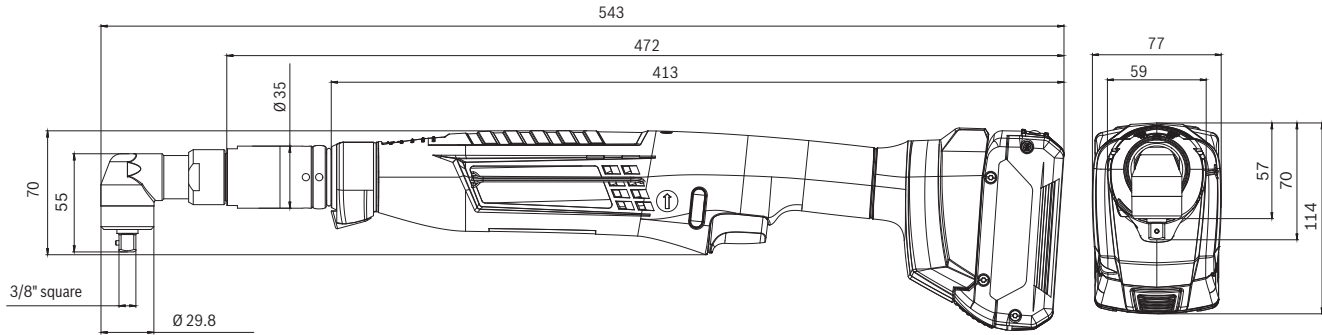

ANGLE EXACT ION model: 30-300, 40-220, 50-210 and 60-120

Dimensions in mm

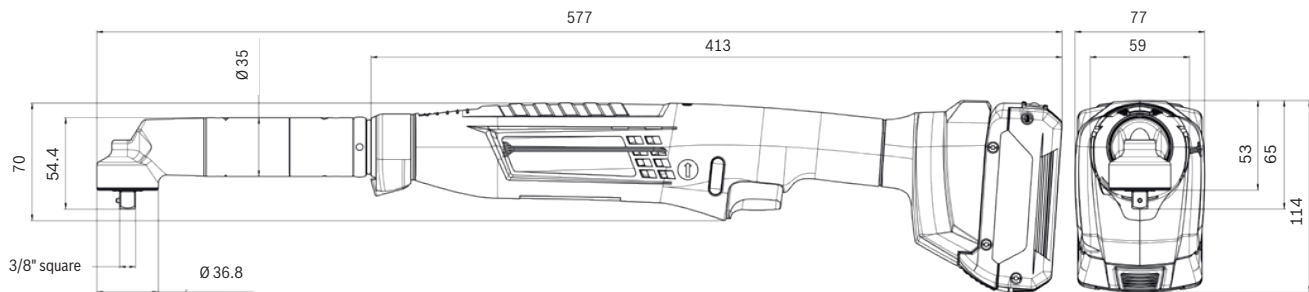

Angel Heads for EXACT ION WK and ANGLE EXACT ION Dimensional drawings



0 607 453 631

Dimensions in mm

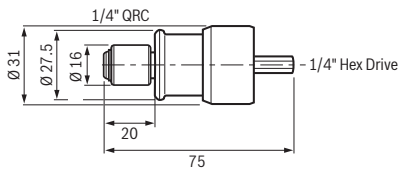

0 607 453 617

Dimensions in mm

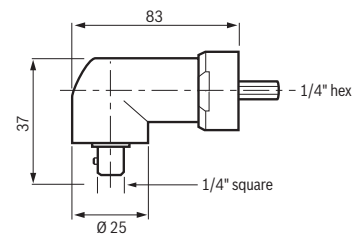

0 607 453 618

Dimensions in mm

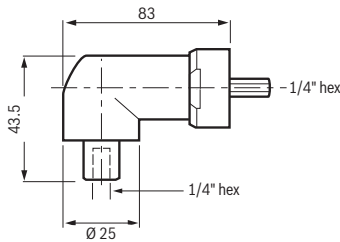

0 607 453 620

Dimensions in mm

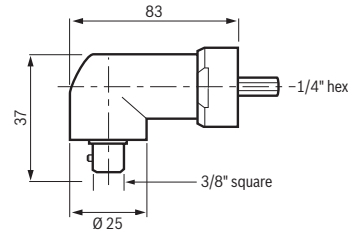

0 607 453 630

Dimensions in mm

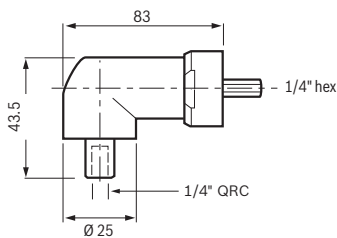

0 607 451 618

Dimensions in mm

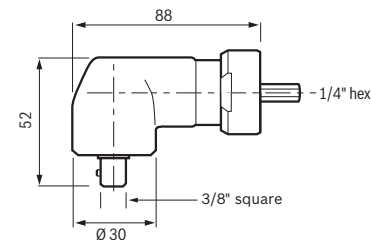

Bosch Rexroth AG

Fornsbacher Straße 92
71540 Murrhardt, Germany
www.boschrexroth.com/tightening

Questions?

Contact our tightening experts:

rfq.jt@boschrexroth.de

Further information online:



Online Product Catalog

Besides of the CAD data, here you can find the firmware service packs for downloading:

www.boschrexroth.com/tightening



Rexroth Media Directory

Here is your 24/7 source for promotional media and technical documentation. Search and download information:

www.boschrexroth.com/mediadirectory

© This document and the data, specifications and other information contained therein are the exclusive property of Bosch Rexroth AG. Reproduction or transfer to third parties is not permitted without their consent.

The data specified above only serve to describe the product. As our products are constantly being further developed, no statements concerning a certain condition or suitability for a certain application can be derived from our information. The information given does not release the user from the obligation of own judgment and verification. It must be remembered that our products are subject to a natural process of wear and aging.

Material no.: R999001899 (2021-02)
© Bosch Rexroth AG 2021
Subject to revisions!
Printed in Germany