

IndraDrive Control Sections

CSB02, CSE02, CSH02, CDB02

Project Planning Manual
R911338962

Edition 04



Title	IndraDrive Control Sections CSB02, CSE02, CSH02, CDB02
Type of Documentation	Project Planning Manual
Document Typecode	DOK-INDRV*-CXX02*****-PR04-EN-P
Internal File Reference	RS-9ac2e632b9c24eef0a6846a50070c7ef-4-en-US-4
Record of Revisions	See chapter 1.1.1 "Editions" on page 7
Copyright	© Bosch Rexroth AG 2019 All rights reserved, also regarding any disposal, exploitation, reproduction, editing, distribution, as well as in the event of applications for industrial property rights.
Liability	The specified data is intended for product description purposes only and shall not be deemed to be a guaranteed characteristic unless expressly stipulated in the contract. All rights are reserved with respect to the content of this documentation and the availability of the product.

Table of Contents

	Page
1 Introduction.....	7
1.1 Documentation.....	7
1.1.1 Editions.....	7
1.1.2 Overview - documentations.....	8
Drive systems, system components.....	8
Motors.....	8
Cables.....	8
Firmware.....	9
1.1.3 Your comments.....	10
1.2 Basic design of an IndraDrive controller.....	11
1.2.1 General information.....	11
1.2.2 Delivery.....	11
1.2.3 Mounting and Dismounting the Control Section.....	11
General Information.....	11
Training.....	11
ESD Protection.....	12
Limited Number of Plug-In Actions.....	12
2 Important directions for use.....	13
2.1 Intended use.....	13
2.1.1 Introduction.....	13
2.1.2 Areas of use and application.....	13
2.2 Unintended use.....	14
3 Safety instructions for electric drives and controls.....	15
3.1 Definitions of terms.....	15
3.2 General information.....	16
3.2.1 Using the Safety instructions and passing them on to others.....	16
3.2.2 Requirements for safe use.....	16
3.2.3 Hazards by improper use.....	18
3.3 Instructions with regard to specific dangers.....	18
3.3.1 Protection against contact with electrical parts and housings.....	18
3.3.2 Protective extra-low voltage as protection against electric shock	20
3.3.3 Protection against dangerous movements.....	20
3.3.4 Protection against electromagnetic and magnetic fields during operation and mounting.....	21
3.3.5 Protection against contact with hot parts.....	22
3.3.6 Protection during handling and mounting.....	22
3.3.7 Battery safety.....	22
3.3.8 Protection against pressurized systems.....	23
3.4 Explanation of signal words and the Safety alert symbol.....	24
4 Identifying the control section.....	25
4.1 Type plates.....	25

Table of Contents

	Page
4.1.1	General information..... 25
4.1.2	Type plates at the drive controller..... 25
4.1.3	Control section type plate..... 26
4.1.4	Firmware type plate..... 26
4.1.5	Control panel type plate..... 27
5	Rexroth IndraDrive control sections..... 29
5.1	Types..... 29
5.1.1	Overview..... 29
5.1.2	Power sections..... 29
5.1.3	Firmware..... 29
5.2	Functions and interfaces..... 30
5.3	Dimensions..... 32
5.4	CSE02..... 33
5.4.1	Type code..... 33
5.4.2	Front view with connection points..... 34
5.5	CSB02..... 35
5.5.1	CSB02.1 type code..... 35
5.5.2	CSB02.5 type code..... 37
5.5.3	Front view with connection points..... 39
5.6	CDB02..... 40
5.6.1	Type code..... 40
5.6.2	Front view with connection points..... 42
5.7	CSH02..... 43
5.7.1	CSH02.1 type code..... 43
5.7.2	CSH02.5 type code..... 45
5.7.3	Front view with connection points..... 47
6	On-board connection points..... 49
6.1	CSB02 interface equipment..... 49
6.2	X4, motor encoder connection..... 50
6.3	X4.1, X4.2, Motor Encoder Connection..... 51
6.4	X24 P2, X25 P1, communication..... 52
6.5	X26, Engineering interface..... 54
6.6	X31 (single-axis), digital inputs, digital output..... 55
6.7	X31 (double-axis), digital inputs, digital output..... 56
6.8	X32 (single-axis), analog input..... 57
6.9	X32 (double-axis), analog input..... 58
6.10	X33, power supply of digital I/Os, Bb relay..... 59
6.11	X35, digital and analog inputs/outputs..... 60
6.12	X36, digital inputs/outputs, analog outputs..... 61
7	Optional connection points..... 63
7.1	Overview..... 63
7.2	X8 or X10, encoder (EC option)..... 65

Table of Contents

	Page
7.3	X8 or X10, encoder emulation (EM option)..... 66
7.4	X22 P2, X23 P1, Multi-Ethernet (ET option)..... 68
7.5	X26, Engineering interface (EP option)..... 69
7.6	X30, PROFIBUS PB..... 70
7.7	X37, digital inputs/outputs (DA option)..... 73
7.8	X38, analog inputs/outputs (DA option)..... 74
7.9	X41, Safe Motion safety technology (S4, S5 options)..... 75
7.10	X41.1, X41.2, Safe Motion safety technology (S4, S5 options)..... 75
7.11	X42, X43, Safe Motion safety technology (communication; S4, S5 options)..... 76
7.12	X42.1, X42.2, X43.1, X43.2, Safe Motion safety technology (communication; S4, S5 options)..... 77
7.13	X48, SBC safety technology (S4, S5, SB options)..... 78
7.14	X48.1, X48.2, SBC safety technology (S4, S5, SB options)..... 78
7.15	X49, optional safety technology Safe Torque Off (L3 option)..... 79
7.16	X49.1, X49.2, optional safety technology Safe Torque Off (L3 option)..... 79
7.17	X61, CANopen (CN Option)..... 80
7.18	Control panels..... 81
7.18.1	Type code..... 81
7.18.2	ADVANCED Control Panel HAP01.1A..... 82
7.18.3	Standard control panel HAP01.1N..... 83
8	Technical data - functions..... 85
8.1	EC - standard encoder evaluation..... 85
8.1.1	Supported encoder systems..... 85
8.1.2	Encoder type..... 86
	IndraDyn S MSM motors (5V supply voltage)..... 86
	IndraDyn S MSK/QSK motors S1/M1, S2/M2, S3/M3, S5/M5 (12 V supply voltage)..... 87
	IndraDyn S MS2N motors AS/AM, BS/BM, CS/CM, HS/HM, DS/DM (12 V supply voltage)..... 88
	HIPERFACE® (12 V supply voltage)..... 90
	EnDat 2.1 according to Heidenhain standard (5 V supply voltage)..... 91
	EnDat 2.2 according to Heidenhain standard (5 V supply voltage)..... 92
	1V _{pp} according to Heidenhain standard (5 V supply voltage)..... 93
	1V _{pp} (12 V supply voltage)..... 94
	TTL (5 V supply voltage)..... 95
	TTL (12 V supply voltage)..... 96
	SSI (5 V supply voltage)..... 97
	SSI (12 V supply voltage)..... 98
	Combined encoder for SSI (5 V supply voltage)..... 99
	Resolvers without encoder data memory..... 100
	Hall sensor box SHL02.1 (12 V supply voltage)..... 101
8.1.3	Power supply..... 102
	5 V power supply..... 102
	12 V power supply..... 102
	Resolver power supply..... 103
8.1.4	Encoder cable length..... 104
8.1.5	Technical data of EC encoder evaluation..... 106

Table of Contents

	Page	
8.1.6	Signal assignment to the actual position value.....	108
8.2	EM - encoder emulation.....	110
8.2.1	Cables.....	110
8.2.2	Incremental encoder emulation.....	110
	Connection.....	110
	Electrical data.....	111
8.2.3	Absolute encoder emulation (SSI format).....	112
	Connection.....	112
	Electrical data.....	112
	Pulse diagram.....	113
8.3	ET - Multi-Ethernet.....	114
8.3.1	Display elements.....	114
8.3.2	Port LED.....	115
	EtherNet/IP.....	115
	EtherCAT.....	115
	sercos III.....	115
	PROFINET IO.....	116
8.3.3	Diagnostic LED.....	117
	EtherNet/IP.....	117
	EtherCAT.....	118
	sercos III.....	119
	PROFINET IO.....	121
8.4	PB - PROFIBUS.....	122
8.5	CN - CANopen.....	123
8.6	Sx - Safe Motion, Safe Motion Bus.....	124
8.6.1	Display elements.....	124
8.7	Digital inputs/outputs.....	126
8.7.1	General Information.....	126
8.7.2	Digital inputs.....	126
	Digital inputs type A (standard).....	126
	Digital inputs type B (probe).....	127
	Digital inputs (safety technology L options).....	128
	Digital inputs (safety technology S options).....	129
8.7.3	Digital outputs.....	130
	Digital outputs (standard).....	130
	Digital outputs (safety technology L options).....	131
	Digital outputs (safety technology S options).....	132
8.8	Analog voltage input.....	134
8.9	Analog current input.....	135
8.10	Analog output.....	136
8.11	Relay Contacts.....	137
8.11.1	Relay Contact Type 2.....	137
9	Technical data - other.....	139
9.1	Power consumption.....	139
9.1.1	General information.....	139

Table of Contents

	Page
9.1.2 Basic circuit boards of control section.....	139
9.1.3 Optional modules.....	140
9.2 Connection points.....	141
9.2.1 General information.....	141
9.2.2 Connection points with spring terminals.....	141
9.2.3 Connection points with screw terminal blocks.....	141
9.3 Analog inputs/outputs: Shield connection.....	142
9.3.1 Analog input.....	142
9.3.2 Analog output.....	142
10 Accessories.....	143
11 Environmental protection and disposal	145
11.1 Environmental protection.....	145
11.2 Disposal.....	145
12 Service and support.....	147
Index.....	149

1 Introduction

1.1 Documentation

1.1.1 Editions

Edition	Release date	Notes
01	2013-09	First edition
02	2014-04	Changes in comparison to previous edition: <ul style="list-style-type: none"> • Included CSx02.5 control sections • Included optional digital and analog inputs/outputs (DA option) • Revised data tables of digital and analog inputs/outputs
03	2015-06	Changes in comparison to previous edition: <ul style="list-style-type: none"> • Updated overview of documentations • Added CSH02.xB-ET control section • Updated type code • Added "Safe Motion Bus" (SB) safety technology • Removed "Safe Stop 1" (S0) safety technology • Changed name of S5 option: "Safe Motion" instead of "Safe Motion Enhanced" • Multi-Ethernet: Updated LED displays • Added shield connection for analog inputs/outputs • Added HAT02
04	2019-03	Changes in comparison to previous edition: <ul style="list-style-type: none"> • Updated overview of control section functions • Updated type code • CSE02, CSB02 connection points: Added X26 (EP option) • Included IndraDyn S MS2N encoder systems AS/AM, BS/BM, CS/CM, HS/HM, DS/DM • Included EnDat 2.2 encoder systems according to Heidenhain standard • Updated encoder emulation (EM option) • Analog current input: Updated data • Analog output: Updated data • Included power consumption of CSE02 control sections • Included power consumption of DA and EP options • Replaced RKB0011 cable by RKB0021 • Replaced RKB0051 cable by RKB0061 • Replaced RKB0052 cable by RKB0062 • Added information on power supply (X33) • Updated information in conjunction with safety technology: Included reference to S4, S5, SB and L3

Tab. 1-1: Editions

Introduction

1.1.2 Overview - documentations

Drive systems, system components

Title IndraDrive ...	Type of documentation	Document typecode ¹⁾ DOK-INDRV*-...	Material number R911...
Drive Systems with HMV01/02 HMS01/02, HMD01, HCS02/03	Project Planning Manual	SYSTEM*****-PRxx-EN-P	309636
Supply Units, Power Sections HMV, HMS, HMD, HCS02, HCS03	Project Planning Manual	HMV-S-D+HCS-PRxx-EN-P	318790
ML, Drive Systems with HMU05	Project Planning Manual	Hxx05*****-PRxx-EN-P	344279
Control Sections CSB02, CSE02, CSH02, CDB02	Project Planning Manual	CSx02-CDB02-PRxx-EN-P	338962
Additional Components and Accessories	Project Planning Manual	ADDCOMP*****-PRxx-EN-P	306140

1) In the document typecodes, "xx" is a placeholder for the current edition of the documentation (e.g.: PR01 is the first edition of a Project Planning Manual)

Tab. 1-2: Documentations – overview

Motors

Title IndraDyn ...	Type of documentation	Document typecode ¹⁾ DOK-MOTOR*-...	Material number R911...
A Asynchronous Motors MAD / MAF	Project Planning Manual	MAD/MAF****-PRxx-EN-P	295781
H Synchronous Kit Spindle Motors	Project Planning Manual	MBS-H*****-PRxx-EN-P	297895
L Synchronous Linear Motors	Project Planning Manual	MLF*****-PRxx-EN-P	293635
S Synchronous Servo Motors MSK	Project Planning Manual	MSK*****-PRxx-EN-P	296289
S Synchronous Servo Motors MS2N	Project Planning Manual	MS2N*****-PRxx-EN-P	347583
T Synchronous Torque Motors	Project Planning Manual	MBT*****-PRxx-EN-P	298798

1) In the document typecodes, "xx" is a placeholder for the current edition of the documentation (e.g.: PR01 is the first edition of a Project Planning Manual)

Tab. 1-3: Documentations – overview

Cables

Title	Type of documentation	Document typecode ¹⁾ DOK-...	Material number R911...
Rexroth Connection Cables IndraDrive and IndraDyn	Selection Data	CONNEX-CABLE*INDRV-CAxx- EN-P	322949

1) In the document typecodes, "xx" is a placeholder for the current edition of the documentation (e.g.: CA02 is the second edition of the "Selection Data" documentation)

Tab. 1-4: Documentations – overview

Firmware

Title IndraDrive ...	Type of documentation	Document typecode ¹⁾ DOK-INDRV*-...	Material number R911...
MPx-20 Functions	Application Manual	MP*-20VRS**-APxx-EN-P	345608
MPx-20 Version Notes	Release Notes	MP*-20VRS**-RNxx-EN-P	345606
Power Supply Basic PSB-20 Functions	Application Manual	PSB-20VRS**-APxx-EN-P	345610
Power Supply Basic PSB-19 Functions	Application Manual	PSB-19VRS**-APxx-EN-P	345602
MPx-18 Functions	Application Manual	MP*-18VRS**-APxx-EN-P	338673
MPx-18 Version Notes	Release Notes	MP*-18VRS**-RNxx-EN-P	338658
MPx-16 to MPx-20 and PSB Parameters	Reference Book	GEN1-PARA**-RExx-EN-P	328651
MPx-16 to MPx-20 and PSB Diagnostics	Reference Book	GEN1-DIAG**-RExx-EN-P	326738
Integrated Safety Technology "Safe Torque Off" (as of MPx-16)	Application Manual	SI3-**VRS**-APxx-EN-P	332634
Integrated Safety Technology "Safe Motion" (as of MPx-18)	Application Manual	SI3*SMO-VRS-APxx-EN-P	338920
Rexroth IndraMotion MLD Libraries as of MPx-18	Reference Book	MLD-SYSLIB3-RExx-EN-P	338916
Rexroth IndraMotion MLD as of MPx-18	Application Manual	MLD3-**VRS*-APxx-EN-P	338914

1) In the document typecodes, "xx" is a placeholder for the current edition of the documentation (e.g.: RE02 is the second edition of a Reference Book)

Tab. 1-5: Documentations – firmware

Title	Type of documentation	Document typecode ¹⁾	Material number R911...
Productivity Agent Extended Diagnostic Functions with Rexroth IndraDrive	Application Manual	DOK-INDRV*-MLD-PAGENT*- AWxx-EN-P	323947

1) In the document typecodes, "xx" is a placeholder for the current edition of the documentation (e.g.: AW01 is the first edition of an Application Manual)

Tab. 1-6: Documentations – overview

Introduction

1.1.3 Your comments



Your experience is important for our improvement processes of products and documentations.

If you find any mistakes in this documentation or have suggestions for changes, please send your feedback to the following address:

Bosch Rexroth AG
Dept. DC-AE/EPI5
Bürgermeister-Dr.-Nebel-Str. 2
97816 Lohr am Main, Germany
Email: dokusupport@boschrexroth.de

1.2 Basic design of an IndraDrive controller

1.2.1 General information

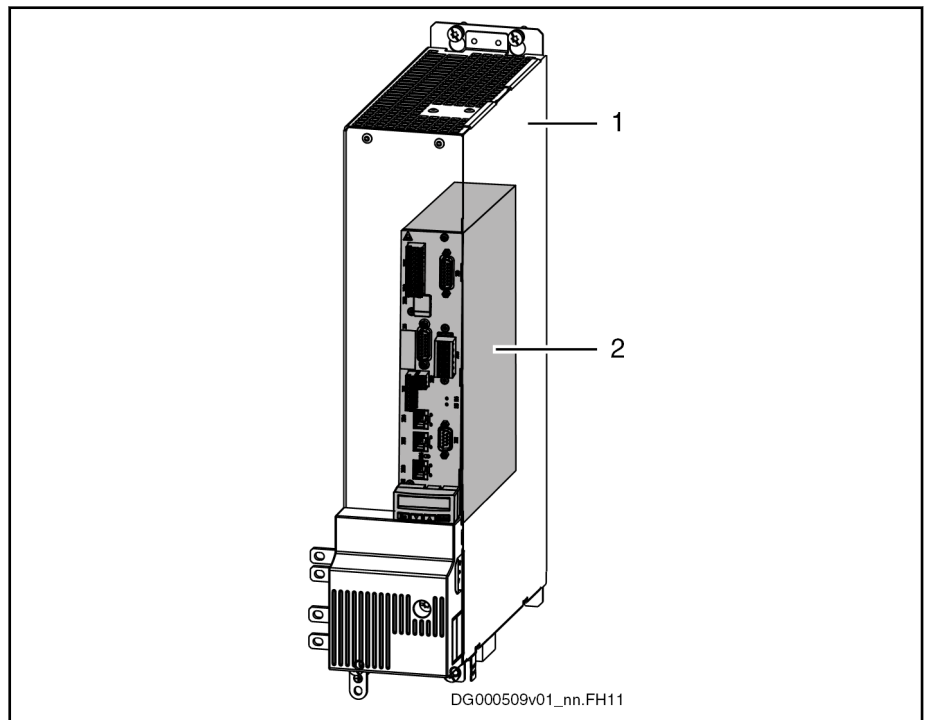

- 1 Power section
2 Control section

Fig. 1-1: Basic design of a Rexroth IndraDrive controller

The drive controller consists of two essential parts:

- Power section
- Control section

1.2.2 Delivery

The control section is a separate component that is plugged into the power section. As a standard, the drive controller is supplied ex works as a complete device including the control section.

Control sections and power sections can also be ordered separately. The respective firmware package has to be simultaneously ordered for control sections.

1.2.3 Mounting and Dismounting the Control Section

General Information

In case the control section is delivered separately, observe the following instructions:

Training

NOTICE

Risk of damage to the control section by improper handling!

Only such persons trained by Rexroth for mounting and dismounting control sections are allowed to mount and dismount control sections.

Introduction

ESD Protection

NOTICE

Risk of damage to the control section and interference with its operational safety caused by electrostatic charges!

Exposed conductive parts coming into contact with the control section must be previously discharged by means of grounding.

Such exposed conductive parts include:

- The human body (ground connection by touching a conductive, grounded object)
- Parts and tools (place them on a conductive support)

Control sections may only be stored or dispatched in conductive packaging.

Limited Number of Plug-In Actions

NOTICE

Risk of damage to the control section or power section by mounting and dismounting the control section too often!

For a drive controller, the control section must not be mounted and dismounted more than a maximum of **20 times**.

2 Important directions for use

2.1 Intended use

2.1.1 Introduction

Rexroth products represent state-of-the-art developments and manufacturing. They are tested prior to delivery to ensure operating safety and reliability.

WARNING

Personal injury and property damage caused by incorrect use of the products!

The products have been designed for use in the industrial environment and may only be used in the intended way. If they are not used in the intended way, situations resulting in property damage and personal injury can occur.



Rexroth as manufacturer is not liable for any damages resulting from unintended use. In such cases, the guarantee and the right to payment of damages resulting from unintended use are forfeited. The user alone carries all responsibility of the risks.

Before using Rexroth products, make sure that all the pre-requisites for an intended use of the products are satisfied:

- Personnel that in any way, shape or form uses our products must first read and understand the relevant safety instructions and be familiar with their intended use.
- If the products take the form of hardware, then they must remain in their original state, in other words, no structural changes are permitted. It is not permitted to decompile software products or alter source codes.
- Do not install damaged or faulty products or put them into operation.
- Make sure that the products have been installed in the manner described in the relevant documentation.

2.1.2 Areas of use and application

Drive controllers made by Rexroth are designed to control electric motors and monitor their operation.

Control and monitoring of the Drive controllers may require additional sensors and actuators.



The drive controllers may only be used with the accessories and parts specified in this documentation. If a component has not been specifically named, then it may neither be mounted nor connected. The same applies to cables and lines.

Operation is only permitted in the specified configurations and combinations of components using the software and firmware as specified in the relevant Functional Descriptions.

Drive controllers have to be programmed before commissioning to ensure that the motor executes the specific functions of an application.

Drive controllers of the Rexroth IndraDrive series have been developed for use in single- and multi-axis drive and control tasks.

To ensure application-specific use of Drive controllers, device types of different drive power and different interfaces are available.

Important directions for use

Typical applications include, for example:

- Handling and mounting systems
- Packaging and food machines
- Printing and paper processing machines
- Machine tools

Drive controllers may only be operated under the assembly and installation conditions described in this documentation, in the specified position of normal use and under the ambient conditions as described (temperature, degree of protection, humidity, EMC, etc.).

2.2 Unintended use

Using the Drive controllers outside of the operating conditions described in this documentation and outside of the indicated technical data and specifications is defined as "unintended use".

Drive controllers may not be used, if ...

- they are subject to operating conditions that do not meet the specified ambient conditions. This includes, for example, operation under water, under extreme temperature fluctuations or extremely high maximum temperatures.
- Furthermore, Drive controllers may not be used in applications which have not been expressly authorized by Rexroth. Please carefully follow the specifications outlined in the general Safety Instructions!



Components of the Rexroth IndraDrive system are **products of Category C3** (with restricted distribution) in accordance with IEC 61800-3. This Category comprises EMC limit values for line-based and radiated noise emission. Compliance with this Category (limit values) requires the appropriate measures of interference suppression to be used in the drive system (e.g., mains filters, shielding measures).

These components are not provided for use in a public low-voltage mains supplying residential areas. If these components are used in such a mains, high-frequency interference is to be expected. This can require additional measures of interference suppression.

3 Safety instructions for electric drives and controls

3.1 Definitions of terms

Application documentation	Application documentation comprises the entire documentation used to inform the user of the product about the use and safety-relevant features for configuring, integrating, installing, mounting, commissioning, operating, maintaining, repairing and decommissioning the product. The following terms are also used for this kind of documentation: Operating Instructions, Commissioning Manual, Instruction Manual, Project Planning Manual, Application Description, etc.
Component	A component is a combination of elements with a specified function, which are part of a piece of equipment, device or system. Components of the electric drive and control system are, for example, supply units, drive controllers, mains choke, mains filter, motors, cables, etc.
Control system	A control system comprises several interconnected control components placed on the market as a single functional unit.
Device	A device is a finished product with a defined function, intended for users and placed on the market as an individual piece of merchandise.
Electrical equipment	Electrical equipment encompasses all devices used to generate, convert, transmit, distribute or apply electrical energy, such as electric motors, transformers, switching devices, cables, lines, power-consuming devices, circuit board assemblies, plug-in units, control cabinets, etc.
Electric drive system	An electric drive system comprises all components from mains supply to motor shaft; this includes, for example, electric motor(s), motor encoder(s), supply units and drive controllers, as well as auxiliary and additional components, such as mains filter, mains choke and the corresponding lines and cables.
Installation	An installation consists of several devices or systems interconnected for a defined purpose and on a defined site which, however, are not intended to be placed on the market as a single functional unit.
Machine	A machine is the entirety of interconnected parts or units at least one of which is movable. Thus, a machine consists of the appropriate machine drive elements, as well as control and power circuits, which have been assembled for a specific application. A machine is, for example, intended for processing, treatment, movement or packaging of a material. The term "machine" also covers a combination of machines which are arranged and controlled in such a way that they function as a unified whole.
Manufacturer	The manufacturer is an individual or legal entity bearing responsibility for the design and manufacture of a product which is placed on the market in the individual's or legal entity's name. The manufacturer can use finished products, finished parts or finished elements, or contract out work to subcontractors. However, the manufacturer must always have overall control and possess the required authority to take responsibility for the product.
Product	Examples of a product: Device, component, part, system, software, firmware, among other things.
Project Planning Manual	A Project Planning Manual is part of the application documentation used to support the sizing and planning of systems, machines or installations.
Qualified persons	In terms of this application documentation, qualified persons are those persons who are familiar with the installation, mounting, commissioning and operation of the components of the electric drive and control system, as well as with the hazards this implies, and who possess the qualifications their

Safety instructions for electric drives and controls

work requires. To comply with these qualifications, it is necessary, among other things,

- to be trained, instructed or authorized to switch electric circuits and devices safely on and off, to ground them and to mark them.
- to be trained or instructed to maintain and use adequate safety equipment.
- to attend a course of instruction in first aid.

Qualified personnel for handling functionally safe products

Individuals configuring, commissioning and operating functionally safe products must have the knowledge specified under "[Qualified persons](#)". Additionally, these individuals must be familiar with technical safety concepts as well as prevailing standards and regulations in the field of functional safety.

User A user is a person installing, commissioning or using a product which has been placed on the market.

3.2 General information

3.2.1 Using the Safety instructions and passing them on to others

Do not attempt to install and operate the components of the electric drive and control system without first reading all documentation provided with the product. Read and understand these safety instructions and all user documentation prior to working with these components. If you do not have the user documentation for the components, contact your responsible Rexroth sales partner. Ask for these documents to be sent immediately to the person or persons responsible for the safe operation of the components.

If the component is resold, rented and/or passed on to others in any other form, these safety instructions must be delivered with the component in the official language of the user's country.

Improper use of these components, failure to follow the safety instructions in this document or tampering with the product, including disabling of safety devices, could result in property damage, injury, electric shock or even death.

3.2.2 Requirements for safe use

Read the following instructions before initial commissioning of the components of the electric drive and control system in order to eliminate the risk of injury and/or property damage. You must follow these safety instructions.

- Rexroth is not liable for damages resulting from failure to observe the safety instructions.
- Read the operating, maintenance and safety instructions in your language before commissioning. If you find that you cannot completely understand the application documentation in the available language, please ask your supplier to clarify.
- Proper and correct transport, storage, mounting and installation, as well as care in operation and maintenance, are prerequisites for optimal and safe operation of the component.
- Only qualified persons may work with components of the electric drive and control system or within its proximity.
- Only use accessories and spare parts approved by Rexroth.

Safety instructions for electric drives and controls

- Follow the safety regulations and requirements of the country in which the components of the electric drive and control system are operated.
- Only use the components of the electric drive and control system in the manner that is defined as appropriate. See chapter "Appropriate Use".
- The ambient and operating conditions given in the available application documentation must be observed.
- Applications for functional safety are only allowed if clearly and explicitly specified in the application documentation "Integrated Safety Technology". If this is not the case, they are excluded. Functional safety is a safety concept in which measures of risk reduction for personal safety depend on electrical, electronic or programmable control systems.
- The information given in the application documentation with regard to the use of the delivered components contains only examples of applications and suggestions.

The machine and installation manufacturers must

- make sure that the delivered components are suited for their individual application and check the information given in this application documentation with regard to the use of the components,
- make sure that their individual application complies with the applicable safety regulations and standards and carry out the required measures, modifications and complements.
- Commissioning of the delivered components is only allowed once it is sure that the machine or installation in which the components are installed complies with the national regulations, safety specifications and standards of the application.
- Operation is only allowed if the national EMC regulations for the application are met.
- The instructions for installation in accordance with EMC requirements can be found in the section on EMC in the respective application documentation.

The machine or installation manufacturer is responsible for compliance with the limit values as prescribed in the national regulations.

- The technical data, connection and installation conditions of the components are specified in the respective application documentations and must be followed at all times.

National regulations which the user has to comply with

- European countries: In accordance with European EN standards
- United States of America (USA):
 - National Electrical Code (NEC)
 - National Electrical Manufacturers Association (NEMA), as well as local engineering regulations
 - Regulations of the National Fire Protection Association (NFPA)
- Canada: Canadian Standards Association (CSA)
- Other countries:
 - International Organization for Standardization (ISO)
 - International Electrotechnical Commission (IEC)

Safety instructions for electric drives and controls

3.2.3 Hazards by improper use

- High electrical voltage and high working current! Danger to life or serious injury by electric shock!
- High electrical voltage by incorrect connection! Danger to life or injury by electric shock!
- Dangerous movements! Danger to life, serious injury or property damage by unintended motor movements!
- Health hazard for persons with heart pacemakers, metal implants and hearing aids in proximity to electric drive systems!
- Risk of burns by hot housing surfaces!
- Risk of injury by improper handling! Injury by crushing, shearing, cutting, hitting!
- Risk of injury by improper handling of batteries!
- Risk of injury by improper handling of pressurized lines!

3.3 Instructions with regard to specific dangers

3.3.1 Protection against contact with electrical parts and housings



This section concerns components of the electric drive and control system with voltages of **more than 50 volts**.

Contact with parts conducting voltages above 50 volts can cause personal danger and electric shock. When operating components of the electric drive and control system, it is unavoidable that some parts of these components conduct dangerous voltage.

High electrical voltage! Danger to life, risk of injury by electric shock or serious injury!

- Only qualified persons are allowed to operate, maintain and/or repair the components of the electric drive and control system.
- Follow the general installation and safety regulations when working on power installations.
- Before switching on, the equipment grounding conductor must have been permanently connected to all electric components in accordance with the connection diagram.
- Even for brief measurements or tests, operation is only allowed if the equipment grounding conductor has been permanently connected to the points of the components provided for this purpose.
- Before accessing electrical parts with voltage potentials higher than 50 V, you must disconnect electric components from the mains or from the power supply unit. Secure the electric component from reconnection.
- With electric components, observe the following aspects:
Always wait **30 minutes** after switching off power to allow live capacitors to discharge before accessing an electric component. Measure the electrical voltage of live parts before beginning to work to make sure that the equipment is safe to touch.

Safety instructions for electric drives and controls

- Install the covers and guards provided for this purpose before switching on.
- Never touch any electrical connection points of the components while power is turned on.
- Do not remove or plug in connectors when the component has been powered.
- Under specific conditions, electric drive systems can be operated at mains protected by residual-current-operated circuit-breakers sensitive to universal current (RCDs/RCMs).
- Secure built-in devices from penetrating foreign objects and water, as well as from direct contact, by providing an external housing, for example a control cabinet.

High housing voltage and high leakage current! Danger to life, risk of injury by electric shock!

- Before switching on and before commissioning, ground or connect the components of the electric drive and control system to the equipment grounding conductor at the grounding points.
- Connect the equipment grounding conductor of the components of the electric drive and control system permanently to the main power supply at all times. The leakage current is greater than 3.5 mA.
- Establish an equipment grounding connection with a minimum cross section according to the table below. With an outer conductor cross section smaller than 10 mm² (8 AWG), the alternative connection of two equipment grounding conductors is allowed, each having the same cross section as the outer conductors.

Cross section outer conductor	Minimum cross section equipment grounding conductor Leakage current ≥ 3.5 mA	
	1 equipment grounding conductor	2 equipment grounding conductors
1.5 mm ² (16 AWG)	10 mm ² (8 AWG)	2 × 1.5 mm ² (16 AWG)
2.5 mm ² (14 AWG)		2 × 2.5 mm ² (14 AWG)
4 mm ² (12 AWG)		2 × 4 mm ² (12 AWG)
6 mm ² (10 AWG)		2 × 6 mm ² (10 AWG)
10 mm ² (8 AWG)	16 mm ² (6 AWG)	-
16 mm ² (6 AWG)		-
25 mm ² (4 AWG)		-
35 mm ² (2 AWG)		-
50 mm ² (1/0 AWG)	25 mm ² (4 AWG)	-
70 mm ² (2/0 AWG)	35 mm ² (2 AWG)	-
...

Tab. 3-1: Minimum cross section of the equipment grounding connection

Safety instructions for electric drives and controls

3.3.2 Protective extra-low voltage as protection against electric shock

Protective extra-low voltage is used to allow connecting devices with basic insulation to extra-low voltage circuits.

On components of an electric drive and control system provided by Rexroth, all connections and terminals with voltages up to 50 volts are PELV ("Protective Extra-Low Voltage") systems. It is allowed to connect devices equipped with basic insulation (such as programming devices, PCs, notebooks, display units) to these connections.

Danger to life, risk of injury by electric shock! High electrical voltage by incorrect connection!

If extra-low voltage circuits of devices containing voltages and circuits of more than 50 volts (e.g., the mains connection) are connected to Rexroth products, the connected extra-low voltage circuits must comply with the requirements for PELV ("Protective Extra-Low Voltage").

3.3.3 Protection against dangerous movements

Dangerous movements can be caused by faulty control of connected motors. Some common examples are:

- Improper or wrong wiring or cable connection
- Operator errors
- Wrong input of parameters before commissioning
- Malfunction of sensors and encoders
- Defective components
- Software or firmware errors

These errors can occur immediately after equipment is switched on or even after an unspecified time of trouble-free operation.

The monitoring functions in the components of the electric drive and control system will normally be sufficient to avoid malfunction in the connected drives. Regarding personal safety, especially the danger of injury and/or property damage, this alone cannot be relied upon to ensure complete safety. Until the integrated monitoring functions become effective, it must be assumed in any case that faulty drive movements will occur. The extent of faulty drive movements depends upon the type of control and the state of operation.

Dangerous movements! Danger to life, risk of injury, serious injury or property damage!

A **risk assessment** must be prepared for the installation or machine, with its specific conditions, in which the components of the electric drive and control system are installed.

As a result of the risk assessment, the user must provide for monitoring functions and higher-level measures on the installation side for personal safety. The safety regulations applicable to the installation or machine must be taken into consideration. Unintended machine movements or other malfunctions are possible if safety devices are disabled, bypassed or not activated.

To avoid accidents, injury and/or property damage:

Safety instructions for electric drives and controls

- Keep free and clear of the machine's range of motion and moving machine parts. Prevent personnel from accidentally entering the machine's range of motion by using, for example:
 - Safety fences
 - Safety guards
 - Protective coverings
 - Light barriers
- Make sure the safety fences and protective coverings are strong enough to resist maximum possible kinetic energy.
- Mount emergency stopping switches in the immediate reach of the operator. Before commissioning, verify that the emergency stopping equipment works. Do not operate the machine if the emergency stopping switch is not working.
- Prevent unintended start-up. Isolate the drive power connection by means of OFF switches/OFF buttons or use a safe starting lockout.
- Make sure that the drives are brought to safe standstill before accessing or entering the danger zone.
- Additionally secure vertical axes against falling or dropping after switching off the motor power by, for example,
 - mechanically securing the vertical axes,
 - adding an external braking/arrester/clamping mechanism or
 - ensuring sufficient counterbalancing of the vertical axes.
- The standard equipment **motor holding brake** or an external holding brake controlled by the drive controller is **not sufficient to guarantee personal safety!**
- Disconnect electrical power to the components of the electric drive and control system using the master switch and secure them from reconnection ("lock out") for:
 - Maintenance and repair work
 - Cleaning of equipment
 - Long periods of discontinued equipment use
- Prevent the operation of high-frequency, remote control and radio equipment near components of the electric drive and control system and their supply leads. If the use of these devices cannot be avoided, check the machine or installation, at initial commissioning of the electric drive and control system, for possible malfunctions when operating such high-frequency, remote control and radio equipment in its possible positions of normal use. It might possibly be necessary to perform a special electromagnetic compatibility (EMC) test.

3.3.4 Protection against electromagnetic and magnetic fields during operation and mounting

Electromagnetic and magnetic fields!

Health hazard for persons with active implantable medical devices (AIMD) such as pacemakers or passive metallic implants.

- Hazards for the above-mentioned groups of persons by electromagnetic and magnetic fields in the immediate vicinity of drive controllers and the associated current-carrying conductors.

Safety instructions for electric drives and controls

- Entering these areas can pose an increased risk to the above-mentioned groups of persons. They should seek advice from their physician.
- If overcome by possible effects on above-mentioned persons during operation of drive controllers and accessories, remove the exposed persons from the vicinity of conductors and devices.

3.3.5 Protection against contact with hot parts

Hot surfaces of components of the electric drive and control system. Risk of burns!

- Do not touch hot surfaces of, for example, braking resistors, heat sinks, supply units and drive controllers, motors, windings and laminated cores!
- According to the operating conditions, temperatures of the surfaces can be **higher than 60 °C** (140 °F) during or after operation.
- Before touching motors after having switched them off, let them cool down for a sufficient period of time. Cooling down can require **up to 140 minutes!** The time required for cooling down is approximately five times the thermal time constant specified in the technical data.
- After switching chokes, supply units and drive controllers off, wait **15 minutes** to allow them to cool down before touching them.
- Wear safety gloves or do not work at hot surfaces.
- For certain applications, and in accordance with the respective safety regulations, the manufacturer of the machine or installation must take measures to avoid injuries caused by burns in the final application. These measures can be, for example: Warnings at the machine or installation, guards (shieldings or barriers) or safety instructions in the application documentation.

3.3.6 Protection during handling and mounting

Risk of injury by improper handling! Injury by crushing, shearing, cutting, hitting!

- Observe the relevant statutory regulations of accident prevention.
- Use suitable equipment for mounting and transport.
- Avoid jamming and crushing by appropriate measures.
- Always use suitable tools. Use special tools if specified.
- Use lifting equipment and tools in the correct manner.
- Use suitable protective equipment (hard hat, safety goggles, safety shoes, safety gloves, for example).
- Do not stand under hanging loads.
- Immediately clean up any spilled liquids from the floor due to the risk of falling!

3.3.7 Battery safety

Batteries consist of active chemicals in a solid housing. Therefore, improper handling can cause injury or property damage.

Risk of injury by improper handling!

Safety instructions for electric drives and controls

- Do not attempt to reactivate low batteries by heating or other methods (risk of explosion and cauterization).
- Do not attempt to recharge the batteries as this may cause leakage or explosion.
- Do not throw batteries into open flames.
- Do not dismantle batteries.
- When replacing the battery/batteries, do not damage the electrical parts installed in the devices.
- Only use the battery types specified for the product.



Environmental protection and disposal! The batteries contained in the product are considered dangerous goods during land, air, and sea transport (risk of explosion) in the sense of the legal regulations. Dispose of used batteries separately from other waste. Observe the national regulations of your country.

3.3.8 Protection against pressurized systems

According to the information given in the Project Planning Manuals, motors and components cooled with liquids and compressed air can be partially supplied with externally fed, pressurized media, such as compressed air, hydraulics oil, cooling liquids and cooling lubricants. Improper handling of the connected supply systems, supply lines or connections can cause injuries or property damage.

Risk of injury by improper handling of pressurized lines!

- Do not attempt to disconnect, open or cut pressurized lines (risk of explosion).
- Observe the respective manufacturer's operating instructions.
- Before dismantling lines, relieve pressure and empty medium.
- Use suitable protective equipment (safety goggles, safety shoes, safety gloves, for example).
- Immediately clean up any spilled liquids from the floor due to the risk of falling!



Environmental protection and disposal! The agents (e.g., fluids) used to operate the product might not be environmentally friendly. Dispose of agents harmful to the environment separately from other waste. Observe the national regulations of your country.

Safety instructions for electric drives and controls

3.4 Explanation of signal words and the Safety alert symbol

The Safety Instructions in the available application documentation contain specific signal words (DANGER, WARNING, CAUTION or NOTICE) and, where required, a safety alert symbol (in accordance with ANSI Z535.6-2011).

The signal word is meant to draw the reader's attention to the safety instruction and identifies the hazard severity.

The safety alert symbol (a triangle with an exclamation point), which precedes the signal words DANGER, WARNING and CAUTION, is used to alert the reader to personal injury hazards.

DANGER

In case of non-compliance with this safety instruction, death or serious injury **will** occur.

WARNING

In case of non-compliance with this safety instruction, death or serious injury **could** occur.

CAUTION

In case of non-compliance with this safety instruction, minor or moderate injury could occur.

NOTICE

In case of non-compliance with this safety instruction, property damage could occur.

4 Identifying the control section

4.1 Type plates

4.1.1 General information

Each drive component is marked by a type designation.

There is a type plate attached to all devices.

4.1.2 Type plates at the drive controller

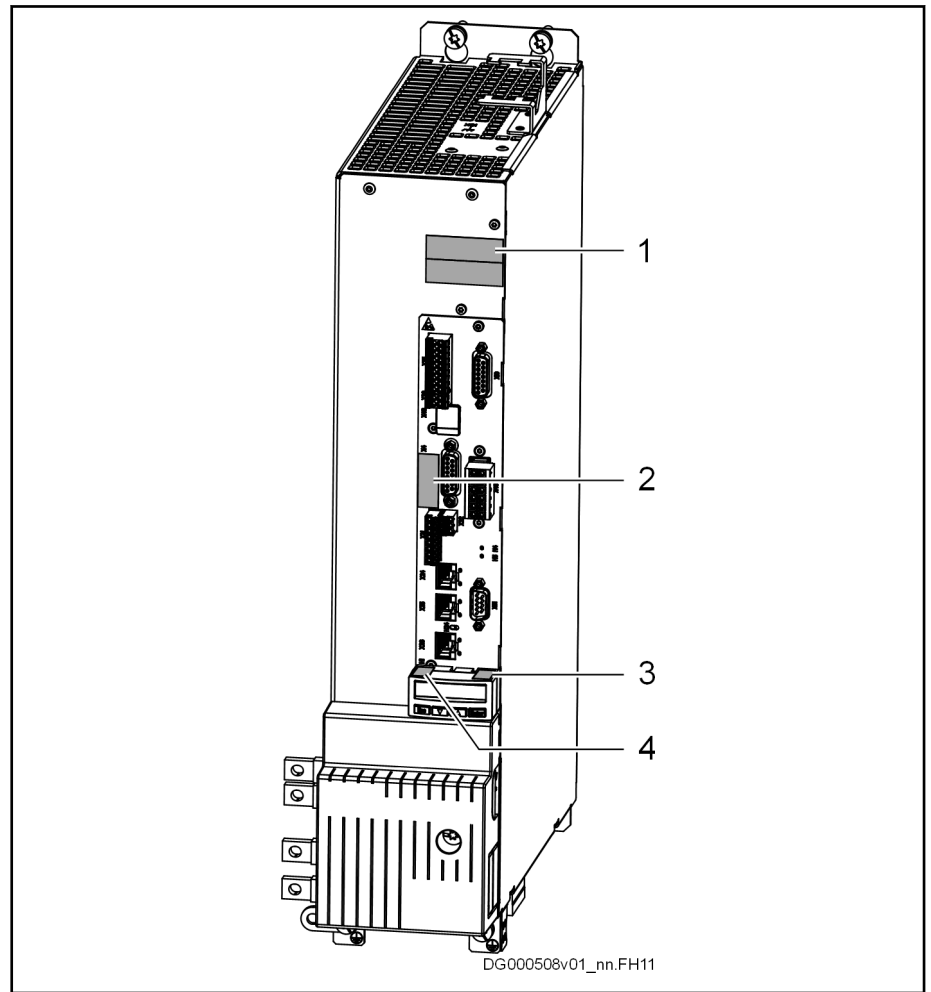

- 1 Power section
- 2 Control section
- 3 Firmware
- 4 Control panel

Fig. 4-1: Type plates at the drive controller

Identifying the control section

4.1.3 Control section type plate

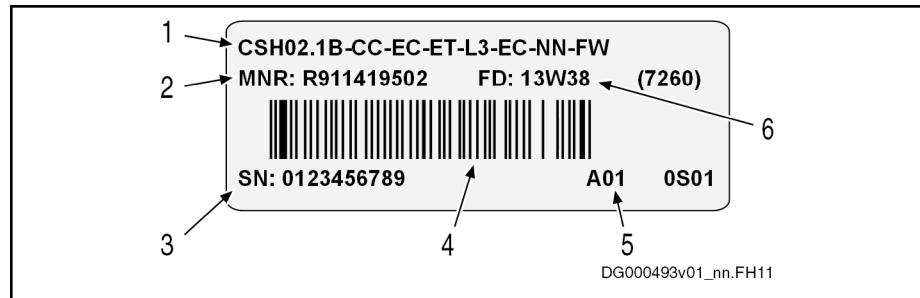

- | | |
|---|--|
| 1 | Type |
| 2 | Material number |
| 3 | Serial number |
| 4 | Bar code |
| 5 | Hardware index |
| 6 | Production week (example: 13W38 means: year 2013, week 38) |

Fig. 4-2: Control section type plate (example)

4.1.4 Firmware type plate

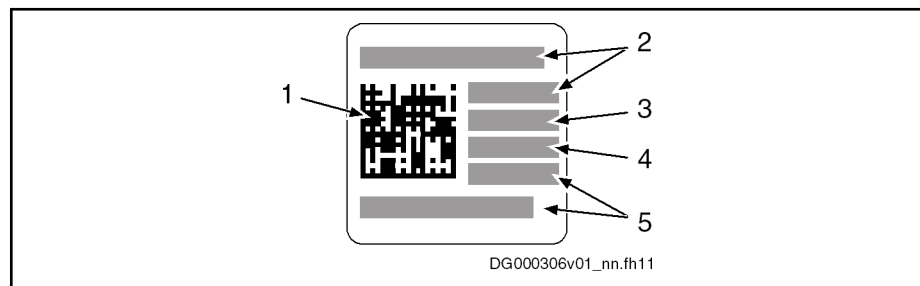

- | | |
|---|--|
| 1 | Bar code |
| 2 | Type |
| 3 | Factory identifier |
| 4 | Production week (example: 13W38 means: year 2013, week 38) |
| 5 | Material number |

Fig. 4-3: Firmware type plate

4.1.5 Control panel type plate

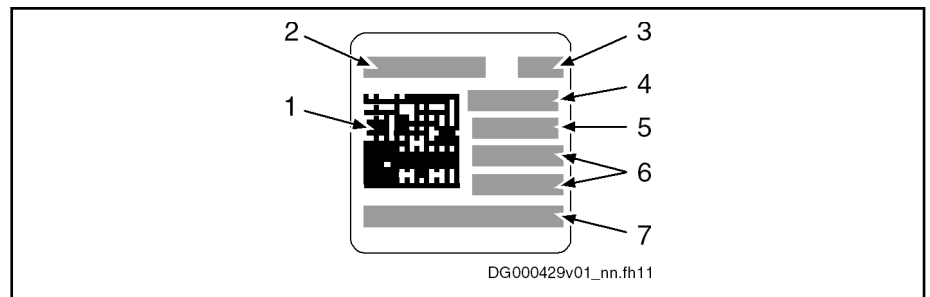

- 1 Bar code
- 2 Type
- 3 Hardware index
- 4 Factory identifier
- 5 Production week (example: 13W38 means: year 2013, week 38)
- 6 Material number
- 7 Serial number

Fig. 4-4: Control panel type plate

5 Rexroth IndraDrive control sections

5.1 Types

5.1.1 Overview

Control section range	Type	Features
ECONOMY	CSE02.1A	Single-axis control section; basic scope
BASIC	CSB02.1A	Single-axis control section; basic scope
	CSB02.1B	Single-axis control section; extended scope
	CSB02.5B	Single-axis control section for universal inverter HMU05; extended scope
	CDB02.1B	Double-axis control section; extended scope
ADVANCED	CSH02.1B	Single-axis control section; extended scope
	CSH02.5B	Single-axis control section for universal inverter HMU05; extended scope

Tab. 5-1: Overview

5.1.2 Power sections

Production week of the power sections

All power sections manufactured since 2007 can use the control sections.
 See power section type plate:
 "FD" has to be at least "07W01".

Supported power sections

Power section	Control section
HCS02	CSB02.1, CSE02.1, CSH02.1
HCS03	
HMS01	
HMS02	
HMU05	CSB02.5, CSH02.5
HMD01	CDB02.1

Tab. 5-2: Assigned power sections

5.1.3 Firmware

Supported firmware

Control sections	Firmware
CSB02.1, CSH02.1 (except for CSH02.1B-ET), CDB02.1	FWA-INDRV*-MPx-18VRS or higher
CSB02.5, CSH02.5 (except for CSH02.5B-ET)	FWA-INDRV*-MPx-19VRS or higher
CSH02.xB-ET, CSE02.1	FWA-INDRV*-MPx-20VRS or higher

Tab. 5-3: Supported firmware

Rexroth IndraDrive control sections

5.2 Functions and interfaces

The control sections differ with regard to

- Configurability
- Available interfaces
- Cycle times or switching frequencies (pulse frequencies)

	CSE02.1A	CSB02.1A	CSB02.xB	CSH02.xB-CC	CSH02.xB-ET	CDB02.1B
Interfaces						
sercos III, EtherCAT (S3)	✓	–	–	–	–	–
Multi-Ethernet (ET)	–	✓	✓	□	✓	✓
sercos III master (CC)	–	–	–	✓	–	–
Encoder evaluation (EC)	✓	✓	✓	✓	✓	✓
Engineering interface (EP)	□	□	□	✓	–	–
Standard control panel	✓	✓	✓	–	–	✓
ADVANCED control panel	□	□	□	✓	✓	–
Number of optional slots	1	2	3	3	3	4
Inputs/outputs:						
Digital inputs ...	7	7	11	11	11	14
... thereof probes	2	2	2	2	2	4
Digital inputs/outputs (arbitrary setting)	1	1	5	5	5	8
Analog inputs ...	1	1	3	3	3	2
... thereof voltage inputs ±10 V	1	1	3	3	3	2
... or current inputs 0...20 mA	–	–	2	2	2	0
Analog outputs ±10 V	–	–	2	2	2	2
Cycle times¹⁾ [µs] :						
Current control	125	62.5 125	62.5 125	62.5	62.5	62.5 125
Velocity control	500	125 250	125 250	125	125	125 250
Position control	1000	250 500	250 500	250	250	250 500
Communication	1000 / 2000	250 500	250 500	250	250	250 500

□

Optional

1)

Cycle times depend on firmware version

Tab. 5-4:

Overview of control section functions

Rexroth IndraDrive control sections

	CSE02.1A	CSB02.1A	CSB02.xB	CSH02.xB-CC	CSH02.xB-ET	CDB02.1B
Options						
CANopen (CN)	–	✓	✓	✓	–	–
PROFIBUS (PB)	–	✓	✓	✓	–	✓
Multi-Ethernet (ET)	–	–	–	✓	–	–
Encoder evaluation (EC)	–	✓	✓	✓	✓	✓
Encoder emulation (EM)	–	✓	✓	✓	✓	✓
Safe Torque Off (L3)	✓	✓	✓	✓	✓	✓
Safe Motion (S4)	–	–	✓	✓	✓	✓
Safe Motion (S5)	–	–	✓	✓	✓	✓
Safe Motion Bus (SB)	–	–	✓	✓	✓	✓
Digital/analog inputs/outputs (DA) ¹⁾	–	–	✓	✓	✓	✓
Engineering interface (EP)	✓	✓	✓	–	–	–

1) See also table below
 Tab. 5-5: Overview of control section options

	DA option: Digital/analog inputs/outputs	
	X37	X38
Digital inputs ...	6	–
... thereof probes	0	–
Digital inputs/outputs (arbitrary setting)	2	–
Digital outputs	6	–
Analog inputs (± 10 V or 0...20 mA) ¹⁾	–	2
Analog outputs (± 10 V)	–	2

1) There is a total of 2 analog inputs. These inputs are multi-purpose inputs. A multi-purpose input is either a voltage input or a current input.
 Tab. 5-6: DA option: Digital/analog inputs/outputs

Rexroth IndraDrive control sections

5.3 Dimensions

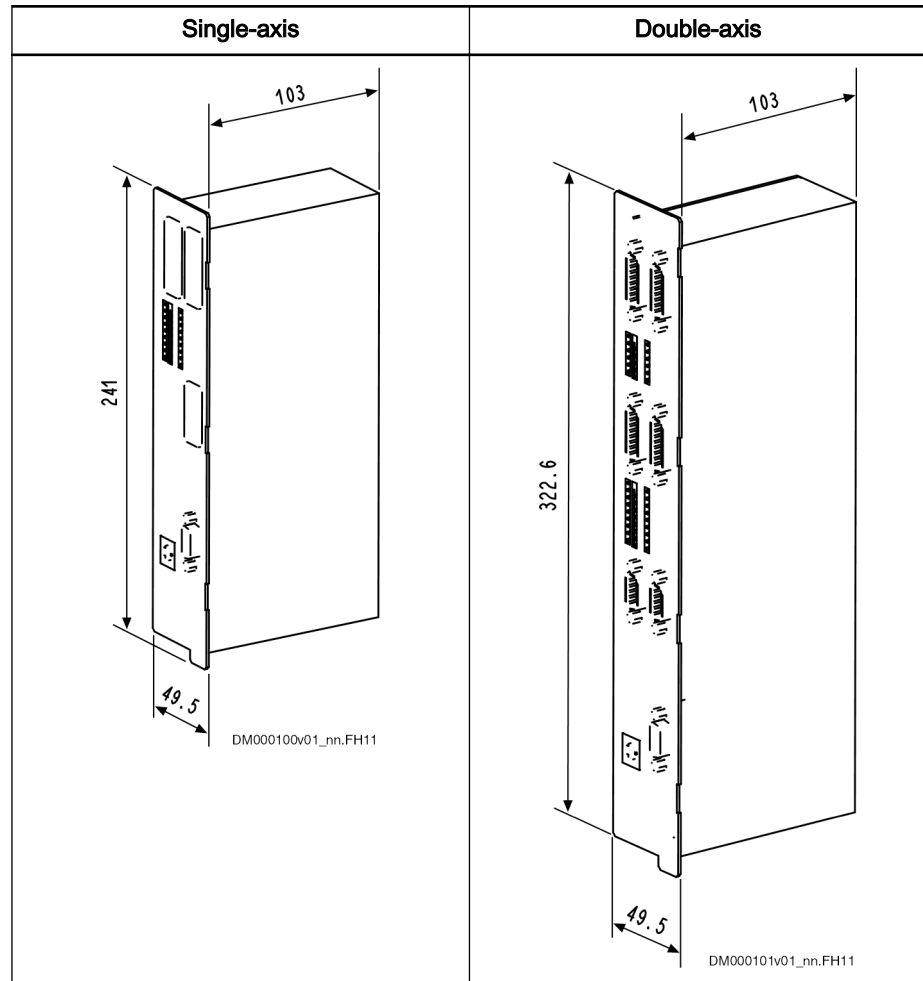

Tab. 5-7: Dimensions



Dimensions for mounting clearance to front: See documentation of power sections.

Rexroth IndraDrive control sections

5.4.2 Front view with connection points

Front view (example)	Connection point	Stranded wire [mm ²]	AWG	Description
	X4	0.25–0.5	-	Encoder evaluation EC
	X24 P2, X25 P1	-	-	Communication sercos III / EtherCAT S3
	X26*	-	-	Engineering interface EP
	X31	0.75–1.5	20–14	Digital inputs/outputs Probe input
	X32	0.75–1.5	20–14	Analog inputs
	X33	0.75–1.5	20–14	Voltage input (24V, 0V) Bb relay
	X49*	0.75–1.5	20–14	Safety technology L3
	H1	-	-	Interface for control panel

*

Optional connection point; the optional connection points are
grayed out in the exemplary figure

Tab. 5-9:

CSE02 connection points

Rexroth IndraDrive control sections

Short type designation	1									2									3									4											
	1	2	3	4	5	6	7	8	9	0	1	2	3	4	5	6	7	8	9	0	1	2	3	4	5	6	7	8	9	0	1	2	3	4	5	6	7	8	9
Example:	C	S	B	0	2	.	1	B	-	E	T	-	E	C	-	P	B	-	L	3	-	E	C	-	N	N	-	F	W										
	①		②			③	④			⑤			⑥			⑦			⑧			⑨			⑩			⑪											
⑩	Other design: NN = None																																						
⑪	Firmware: AW = With Advanced control panel, firmware has to be ordered separately FW = With Standard control panel, firmware has to be ordered separately NW = Without control panel, without firmware																																						

- 1) The L3, S4, S5 and SB interfaces guarantee both the function and the certification
- 2) Only if interface equipment = B
- 3) Only if interface equipment = B and interface 2 = PB, CN or EP
- 4) Only if interface equipment = B and interface 2 = PB, CN, EP or EC

Tab. 5-10: CSB02.1 type code



The figure illustrates the basic structure of the type code. Our sales representative will help you with the current status of available versions.

Rexroth IndraDrive control sections

5.6.2 Front view with connection points

Front view ²⁾ (example)	Connection point ¹⁾	Stranded wire [mm ²]	AWG	Description
	X4.1 X4.2	0.25–0.5	-	Encoder evaluation EC
	X8*	0.25–0.5	-	Encoder evaluation EC Encoder emulation EM
	X10*	0.25–0.5	-	Encoder evaluation EC Encoder emulation EM
	X24 P2, X25 P1	-	-	Multi-Ethernet communication ET
	X30*	0.25–0.5	-	PROFIBUS communication PB
	X31	0.75–1.5	20–14	Digital inputs/outputs Probe input
	X32	0.75–1.5	20–14	Analog inputs
	X33	0.75–1.5	20–14	Voltage input (24V, 0V) Bb relay
	X36	0.75–1.5	20–14	Digital inputs and outputs; analog outputs (voltage)
	X37*	0.75–1.5	20–14	Digital inputs/outputs DA
	X38*	0.75–1.5	20–14	Analog inputs/outputs DA
	X41.1* X41.2*	0.75–1.5	20–14	Safety technology S4, S5, SB (SB: X41, X42, X43 not available; LEDs available)
	X42.1 / X43.1* X42.2 / X43.2*	-	-	
	X48.1* X48.2*	0.75–1.5	20–14	Safety technology (Only available in conjunction with safety technology S4, S5, SB)
	X49.1* X49.2*	0.75–1.5	20–14	Safety technology L3
	H1	-	-	Interface for control panel

- 1) Connection points of axis 1 have the extension ".1" (e.g. X4.1); connections of axis 2 have the extension ".2" (e.g. X4.2)
- 2) The numbers in brackets refer to the interface numbers in the type code; for example, [3] in the above illustration is interface 3 in the type code (position ③)
- * Optional connection point; the optional connection points are grayed out in the exemplary figure

Tab. 5-14: CDB02 connection points

Rexroth IndraDrive control sections

Short type designation	1									2									3									4											
	1	2	3	4	5	6	7	8	9	0	1	2	3	4	5	6	7	8	9	0	1	2	3	4	5	6	7	8	9	0	1	2	3	4	5	6	7	8	9
Example:	C	S	H	0	2	.	1	B	-	C	C	-	E	C	-	E	T	-	N	N	-	D	A	-	N	N	-	F	W										
	①		②			③	④			⑤			⑥			⑦			⑧			⑨			⑩			⑪											
⑩	Other design: NN = None																																						
⑪	Firmware: FW = Firmware must be ordered as a separate subposition																																						

- 1) Only if communication = CC
 - 2) The L3, S4, S5 and SB interfaces guarantee both the function and the certification
 - 3) Only if interface 2 = ET, PB, CN or EC
- Tab. 5-15: CSH02.1 type code



The figure illustrates the basic structure of the type code. Our sales representative will help you with the current status of available versions.

5.7.3 Front view with connection points

Front view ²⁾ (example)	Connection point	Stranded wire [mm ²]	AWG	Description
	X4	0.25–0.5	-	Encoder evaluation EC
	X8*	0.25–0.5	-	Encoder evaluation EC Encoder emulation EM
	X10*	0.25–0.5	-	Encoder evaluation EC Encoder emulation EM
	X22 P2, X23 P1*	-	-	Multi-Ethernet communication ET
	X24 P2, X25 P1	-	-	sercos III master (CC) Multi-Ethernet (ET)
	X26	-	-	Engineering interface (Only available for CSH02.xB-CC)
	X30*	0.25–0.5	-	PROFIBUS communication PB
	X31	0.75–1.5	20–14	Digital inputs/outputs Probe input
	X32	0.75–1.5	20–14	Analog inputs
	X33	0.75–1.5	20–14	Voltage input (24V, 0V) Bb relay
	X35	0.75–1.5	20–14	Digital inputs and outputs; analog inputs (current/voltage); analog outputs (voltage)
	X37*	0.75–1.5	20–14	Digital inputs/outputs
	X38*	0.75–1.5	20–14	Analog inputs/outputs
	X41*	0.75–1.5	20–14	Safety technology S4, S5, SB (SB: X41, X42, X43 not available; LEDs available)
	X42 / X43*	-	-	
	X48*	0.75–1.5	20–14	Safety technology (Only available in conjunction with safety technology S4, S5, SB)
	X49*	0.75–1.5	20–14	Safety technology L3
	X61*	0.25–0.5	-	CANopen communication CN
	H1	-	-	Interface for control panel

* Optional connection point; the optional connection points are grayed out in the exemplary figure
 2) The numbers in brackets refer to the interface numbers in the type code; for example, [2] in the above illustration is interface 2 in the type code (position ⑦)

Tab. 5-17: CSH02 connection points

6 On-board connection points

6.1 CSB02 interface equipment

The number of on-board connection points of a **CSB02** control section depends on the interface equipment (see type code):

- **A** (basic scope)
- **B** (extended scope)

CSB02	Interface equipment	
	A	B
X4	✓	✓
X31	✓	✓
X32	✓	✓
X33	✓	✓
X35	–	✓

Tab. 6-1: Interface equipment

On-board connection points

6.2 X4, motor encoder connection

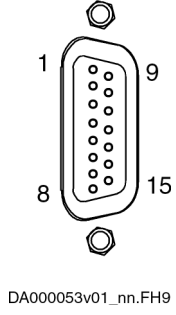
View	Identification	Function	
 <p>DA000053v01_nn.FH9</p>	X4	Motor encoder connection	
D-Sub, 15-pin, female	Unit	min.	max.
Connection cable Stranded wire	mm ²	0.25	0.5
Type of encoder evaluation		EC	

Tab. 6-2: Function, properties

Technical data [chapter 8.1 "EC - standard encoder evaluation" on page 85](#)

Supported encoder systems

Encoder systems with a supply voltage of **5 and 12 V**:

- MSM motor encoder
- MSK motor encoder
- MS2N motor encoder
- 1V_{pp} sin-cos encoder; HIPERFACE®
- 1V_{pp} sin-cos encoder; EnDat 2.1
- 1V_{pp} sin-cos encoder; with reference track
- 5V-TTL square-wave encoder; with reference track
- SSI
- Combined encoder for SSI (combination of SSI and 1V_{pp} sin-cos encoder)
- EnDat 2.2
- Resolver (resolvers are **not** supported if an optional S4 safety technology is available at the same time.)
- SHL02.1 Hall sensor box
- Digital Hall sensor in conjunction with SHL03.1 Hall sensor adapter box

On-board connection points

Pin Assignment	Connection	Signal	Function
	1	GND_shld	Connection signal shields (internal shields)
	2	A+	Track A analog positive
	3	A-	Track A analog negative
	4	GND_Encoder	Reference potential power supplies
	5	B+	Track B analog positive
	6	B-	Track B analog negative
	7	EncData+	Data transmission positive
		A+TTL	Track A TTL positive
	8	EncData-	Data transmission negative
		A-TTL	Track A TTL negative
	9	R+	Reference track positive
	10	R-	Reference track negative
	11	+12V	Encoder supply 12V
	12	+5V	Encoder supply 5V
	13	EncCLK+	Clock positive
		B+TTL	Track B TTL positive
	14	EncCLK-	Clock negative
		B-TTL	Track B TTL negative
	15	Sense-	Return of reference potential (Sense line)
		VCC_Resolver	Resolver supply
	Connector housing		Overall shield

Tab. 6-3: Pin Assignment

6.3 X4.1, X4.2, Motor Encoder Connection

Encoder Evaluation at Double-Axis Control Sections

- X4.1: Axis 1
- X4.2: Axis 2

Pin Assignment [chapter 6.2 "X4, motor encoder connection" on page 50](#)

Technical Data [chapter 8.1 "EC - standard encoder evaluation" on page 85](#)

On-board connection points

6.4 X24 P2, X25 P1, communication

Control section type	Function
ECONOMY	sercos III, EtherCAT (S3) Communication module for sercos III and EtherCAT field bus systems
BASIC	Multi-Ethernet (ET) With the Multi-Ethernet communication module "ET", drive controllers can be integrated in different Ethernet field bus systems (e.g. sercos III, EtherCAT, EtherNet/IP or PROFINET IO).
ADVANCED	<ul style="list-style-type: none"> sercos III master (CC) Is used as "master" for cross communication (CC = Cross Communication) Multi-Ethernet (ET) With the Multi-Ethernet communication module "ET", drive controllers can be integrated in different Ethernet field bus systems (e.g. sercos III, EtherCAT, EtherNet/IP or PROFINET IO).

Tab. 6-4: X24 P2, X25 P1, communication

Description

The connection point complies with IEEE 802.3 standard.

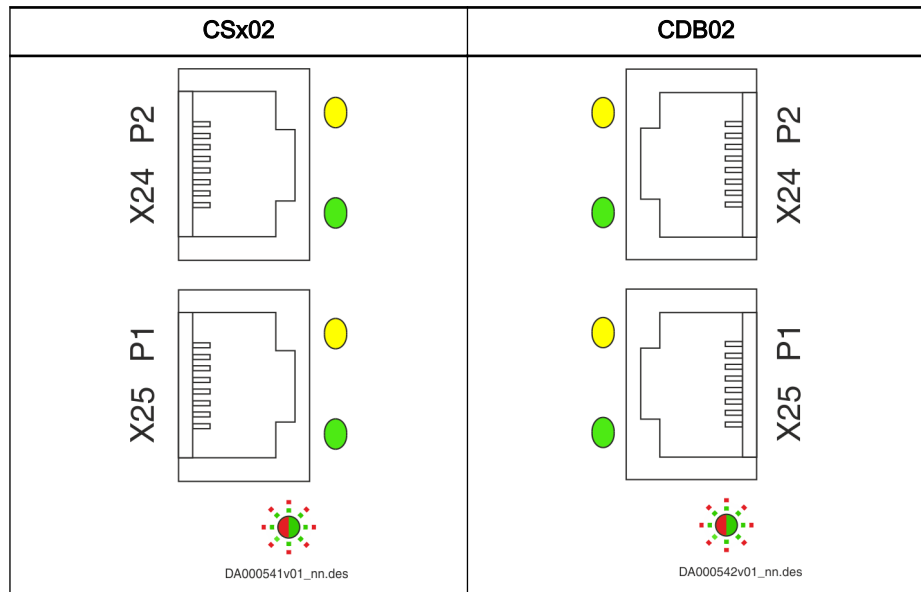

Tab. 6-5: Connection point

P1, P2 P1 means "Port 1" and P2 means "Port 2". Thereby, the error counter of the firmware can be directly assigned to a Port.

Connection *sercos III, EtherNet/IP, PROFINET:*

- Input: arbitrary
- Output: arbitrary

EtherCAT:

- Input: X25 P1
- Output: X24 P2

On-board connection points

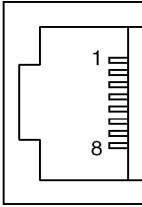
View	Connection	Signal name	Function
 <p>DA000041v01_nn.FH</p>	1	TD+	Transmit, Differential Output A
	2	TD-	Transmit, Differential Output B
	3	RD+	Receive, Differential Input A
	4	n. c.	-
	5	n. c.	-
	6	RD-	Receive, Differential Input B
	7	n. c.	-
	8	n. c.	-
	Housing		Shield connection
Properties			
Standard	<ul style="list-style-type: none"> Ethernet Type: RJ-45, 8-pin 		
Compatibility	100Base-TX according to IEEE 802.3u		
Recommended cable type	<ul style="list-style-type: none"> According to CAT5e; ITP type of shield (Industrial Twisted Pair) Ready-made cables that can be ordered: <ul style="list-style-type: none"> RKB0021 Long cables (100 m at maximum) to connect the drive system to the higher-level control unit or remote communication nodes. Minimum bending radius: <ul style="list-style-type: none"> 48.75 mm with flexible installation 32.50 mm with permanent installation Order code for a 30 m long cable: RKB0021/030,0 RKB0013 Short cables to connect devices arranged side by side in the control cabinet. 4 lengths available: 0.19 m; 0.25 m; 0.35 m; 0.55 m Order code for a 0.55 m long cable: RKB0013/00,55 Minimum bending radius: 30.75 mm 		

Tab. 6-6: Function, pin assignment, properties

LEDs [chapter 8.3 "ET - Multi-Ethernet" on page 114](#)

On-board connection points

6.5 X26, Engineering interface

Description Exclusively at CSH02.xB-CC ADVANCED devices and devices with EP option.

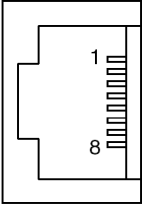
View	Connection	Signal name	Function
 <p>DA000041v01_nn.FH</p>	1	TD+	Transmit, Differential Output A
	2	TD-	Transmit, Differential Output B
	3	RD+	Receive, Differential Input A
	4	n. c.	-
	5	n. c.	-
	6	RD-	Receive, Differential Input B
	7	n. c.	-
	8	n. c.	-
	Housing		Shield connection
Properties			
Standard	<ul style="list-style-type: none"> Ethernet Type: RJ-45, 8-pin 		
Compatibility	100Base-TX according to IEEE 802.3u		
Recommended cable type	<ul style="list-style-type: none"> According to CAT5e; ITP type of shield (Industrial Twisted Pair) Ready-made cables that can be ordered: <ul style="list-style-type: none"> – RKB0021 Long cables (100 m at maximum) to connect the drive system to the higher-level control unit or remote communication nodes. Minimum bending radius: <ul style="list-style-type: none"> – 48.75 mm with flexible installation – 32.50 mm with permanent installation Order code for a 30 m long cable: RKB0021/030,0 – RKB0013 Short cables to connect devices arranged side by side in the control cabinet. 4 lengths available: 0.19 m; 0.25 m; 0.35 m; 0.55 m Order code for a 0.55 m long cable: RKB0013/00,55 Minimum bending radius: 30.75 mm 		

Tab. 6-7: Function, pin assignment, properties

6.6 X31 (single-axis), digital inputs, digital output

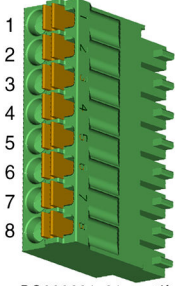
View	Connection	Signal name	Function	Default assignment
 DG000291v01_nn.tif	1	I_1	Digital input (type B)	Probe 1
	2	I_2		Probe 2
	3	I_3	Digital input (type A)	E-Stop input
	4	I_4		Travel range limit switch input
	5	I_5		Travel range limit switch input
	6	I_6		Not assigned
	7	I_7	Not assigned	
	8	I_8/O_1	Digital input/output (input: type A)	Not assigned
Spring terminal (connector)	Unit	min.	max.	
Connection cable	mm ²	0.2	1.5	
Stranded wire	AWG	24	16	
Stripped length	mm	-	10	

Tab. 6-8: Function, pin assignment, properties

Power supply X33/1.1 is the power supply connection for the digital inputs and outputs. The digital inputs and outputs only take effect when the power supply has been connected.

GND Reference X33/1.2 is the GND reference of the digital inputs and outputs.

Technical data [chapter 8.7.2 "Digital inputs" on page 126](#)
[chapter 8.7.3 "Digital outputs" on page 130](#)

On-board connection points

6.7 X31 (double-axis), digital inputs, digital output

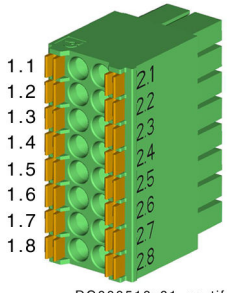
View	Connection	Signal name	Connection	Signal name	Function	Default assignment
 DG000510v01_nn.tif	1.1	I_1	2.1	I_9	Digital input (type B)	Probe
	1.2	I_2	2.2	I_10		Probe
	1.3	I_3	2.3	I_11	Digital input (type A)	E-Stop input
	1.4	I_4	2.4	I_12		Travel range limit switch input
	1.5	I_5	2.5	I_13		Travel range limit switch input
	1.6	I_6	2.6	I_14		Not assigned
	1.7	I_7	2.7	I_15		Not assigned
	1.8	I_8/O_1	2.8	I_16/O_2		Digital input/output (input: type A)
Spring terminal (connector)	Unit	min.	max.			
Connection cable	mm ²	0.2	1.5			
Stranded wire	AWG	24	16			
Stripped length	mm	-	10			

Tab. 6-9: Function, pin assignment, properties

Power supply X33/1.1 is the power supply connection for the digital inputs and outputs.
The digital inputs and outputs only take effect when the power supply has been connected.

GND Reference X33/1.2 is the GND reference of the digital inputs and outputs.

Technical data [chapter 8.7.2 "Digital inputs" on page 126](#)
[chapter 8.7.3 "Digital outputs" on page 130](#)

6.8 X32 (single-axis), analog input

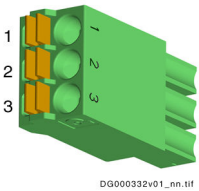
View	Connection	Signal name	Function
 <p>DG000332v01_nm.tif</p>	1	GND_100	Connection for inner cable shield
	2	IA_1-	Analog differential input
	3	IA_1+	
Spring terminal (connector)	Unit	min.	max.
Connection cable	mm ²	0.2	1.5
	Stranded wire AWG	24	16
Stripped length	mm	-	10
Shielding	-	-	For cable lengths > 30 m, use shielded cables only.

Tab. 6-10: Function, pin assignment, properties

Shield connection [chapter 9.3 "Analog inputs/outputs: Shield connection" on page 142](#)

Technical data [chapter 8.8 "Analog voltage input" on page 134](#)

On-board connection points

6.9 X32 (double-axis), analog input

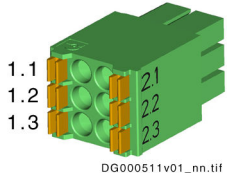
View	Connection	Signal name	Connection	Signal name	Function
	1.1	GND_100	2.1	GND_100	Connection for inner cable shield
	1.2	IA_1-	2.2	IA_2-	Analog differential input
	1.3	IA_1+	2.3	IA_2+	
Spring terminal (connector)	Unit	min.	max.		
Connection cable	mm ²	0.2	1.5		
Stranded wire	AWG	24	16		
Stripped length	mm	-	10		
Shielding	-	-	For cable lengths > 30 m, use shielded cables only.		

Tab. 6-11: Function, pin assignment, properties

Shield connection [chapter 9.3 "Analog inputs/outputs: Shield connection" on page 142](#)

Technical data [chapter 8.8 "Analog voltage input" on page 134](#)

6.10 X33, power supply of digital I/Os, Bb relay

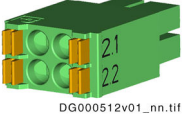
View	Connection	Signal name	Function
 DG000512v01_nn.tif	1.1	24V_EA	Power supply of the digital inputs and outputs ¹⁾
	1.2	0V_EA	GND reference of the digital inputs and outputs ¹⁾
	2.1	Rel1.1	Bb relay
	2.2	Rel1.2	Bb relay
Spring terminal (connector)	Unit	min.	max.
Connection cable	mm ²	0.2	1.5
Stranded wire	AWG	24	16
Stripped length	mm	10	10

1) Also used for supplying power to X48 "SBC safety technology".
 Tab. 6-12: *Function, pin assignment, properties*



PELV¹⁾ for 24V power supply unit

For the 24V supply of the devices of the Rexroth IndraDrive range, use a power supply unit or a control-power transformer with protection by PELV according to IEC 60204-1 (section 6.4).

In the scope of CSA/UL, the data of the control-power transformer are limited to:

- Max. output voltage: 42.4 V_{peak} or 30 V_{ac}
- Max. output power: 10000 VA

Technical data Bb relay: [chapter 8.11.1 "Relay Contact Type 2" on page 137](#)

¹⁾ *Protective Extra Low Voltage*

On-board connection points

6.11 X35, digital and analog inputs/outputs

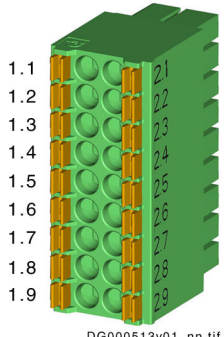
View	Connection	Signal name	Connection	Signal name	Function	
 DG000513v01_nn.tif	1.1	IA_2+	2.1	IA_3+	Analog input	
	1.2	IA_2-	2.2	IA_3-		
	1.3	GND_100	2.3	GND_100	Connection for inner cable shield	
	1.4	OA_1	2.4	OA_2	Analog output	
	1.5	GND_A1	2.5	GND_A2	GND reference of analog output	
	1.6	I_9/O_2	2.6	I_13	Digital input/output	Digital input
	1.7	I_10/O_3	2.7	I_14		
	1.8	I_11/O_4	2.8	I_15		
	1.9	I_12/O_5	2.9	I_16		
Spring terminal (connector)	Unit	min.	max.			
Connection cable	mm ²	0.2	1.5			
Stranded wire	AWG	24	16			
Stripped length	mm	-	10			

Tab. 6-13: Function, pin assignment, properties

GND Reference X33/1.2 is the GND reference of the digital inputs and outputs.

Shield connection [chapter 9.3 "Analog inputs/outputs: Shield connection" on page 142](#)

Technical data [chapter 8.7.2 "Digital inputs" on page 126](#)
[chapter 8.7.3 "Digital outputs" on page 130](#)
[chapter 8.8 "Analog voltage input" on page 134](#)
[chapter 8.9 "Analog current input" on page 135](#)
[chapter 8.10 "Analog output" on page 136](#)



The connection point is only available at single-axis control sections.

6.12 X36, digital inputs/outputs, analog outputs

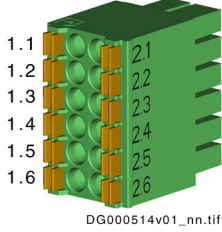
View	Connection	Signal name	Connection	Signal name	Function
	1.1	OA_1	2.1	OA_2	Analog output
	1.2	GND_A1	2.2	GND_A2	GND reference of analog output
	1.3	GND_100	2.3	GND_100	GND reference Connection for inner cable shield
	1.4	I_17/O_3	2.4	I_20/O_6	Digital input/output
	1.5	I_18/O_4	2.5	I_21/O_7	
	1.6	I_19/O_5	2.6	I_22/O_8	
Spring terminal (connector)	Unit	min.	max.		
Connection cable	mm ²	0.2	1.5		
Stranded wire	AWG	24	16		
Stripped length	mm	-	10		

Tab. 6-14: Function, pin assignment, properties

GND Reference X33/1.2 is the GND reference of the digital inputs and outputs.

Shield connection [chapter 9.3 "Analog inputs/outputs: Shield connection" on page 142](#)

Technical data [chapter 8.7.2 "Digital inputs" on page 126](#)
[chapter 8.7.3 "Digital outputs" on page 130](#)
[chapter 8.10 "Analog output" on page 136](#)



The connection point is only available at double-axis control sections.

7 Optional connection points

7.1 Overview

Optional module	Function	Name of option Connection point	Notes
Communication	CANopen	CN X61	CANopen field bus Applies to: BASIC CSB02.1B, ADVANCED
	PROFIBUS	PB X30	PROFIBUS field bus Applies to: BASIC, ADVANCED
	Multi-Ethernet	ET X22 P2, X23 P1	Ethernet-based communication Applies to: ADVANCED
Inputs/outputs	Digital and analog inputs/ outputs	DA X37, X38	X37: Digital inputs/outputs (6 inputs, 6 outputs, 2 inputs/outputs) X38: Analog inputs/outputs (2 inputs [current or voltage], 2 outputs)
Encoder evaluation	Multi-encoder systems	EC X8, X10	Applies to: BASIC, ADVANCED
Encoder emulation	Emulation of absolute and incremental encoders	EM X8, X10	Emulation absolute encoder in SSI format Applies to: BASIC, ADVANCED At most 1 × EM per axis
Safety technology	Safe Motion	S4 X41, X42, X43	Applies to: BASIC CSB02.1B, BASIC CDB02.1B, ADVANCED
	Safe Motion	S5 X41, X42, X43	Applies to: BASIC CSB02.1B, BASIC CDB02.1B, ADVANCED <i>Option S5 supports:</i> <ul style="list-style-type: none"> • All safety functions, as does option S4 • Two encoder evaluations • Resolver encoder evaluation
	Safe Motion Bus	SB No separate connection point	Applies to: BASIC CSB02.1B, BASIC CDB02.1B, ADVANCED The safety functions are implemented via the communication.
	Safe Torque Off	L3 X49	Applies to: ECONOMY, BASIC, ADVANCED
Engineering	Ethernet	EP X26	Applies to: ECONOMY, BASIC

Optional connection points

Optional module	Function	Name of option Connection point	Notes
Control panel	Standard control panel	HAP01.1N H1	Single-line display without a slot for a microSD memory card
	ADVANCED control panel	HAP01.1A H1	Single-line display with a slot for a microSD memory card and additional FRAM for MLD retain variables
Memory	Exchangeable medium for parameters and firmware	PFM04.1	microSD memory card for control panel

Tab. 7-1: Available optional modules

7.2 X8 or X10, encoder (EC option)

Technical Data [chapter 6.2 "X4, motor encoder connection" on page 50](#)

Optional connection points

7.3 X8 or X10, encoder emulation (EM option)

Description Emulation of absolute value and incremental encoder signals for further evaluation by a control unit. The signals are galvanically isolated from the circuit board.

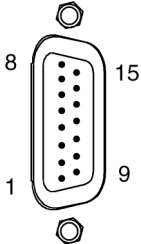
View	Identificati on	Function	
 <p>DA000056v01_nn.FH9</p>	X8 X10	Encoder emulation	
D-Sub 15-pin, male	Unit	min.	max.
Connection cable Stranded wire	mm ²	0.25	0.5

Tab. 7-2: Function, pin assignment, properties

- Emulated encoder systems**
- Incremental encoder (RS422)
 - Incremental encoder (single-ended)
 - Absolute encoder (SSI encoder)

Optional connection points

Pin assignment

Connection	Signal	Level	Input/Output	Function	Incremental encoder (RS422)	SSI encoder	Incremental encoder (single-ended)
1	n. c.	-	-	Not assigned			
2	UL	U_{ext}	In	Power supply for output driver			✓
3	SSI_CLK+	RS422	In	SSI clock positive		✓	
4	SSI_CLK-	RS422	In	SSI clock negative		✓	
5	n. c.	-	-	Not assigned			
6	ULA0	U_{out}	Out	Reference track with UL level			✓
7	ULA1	U_{out}	Out	Track A1 with UL level			✓
8	ULA2	U_{out}	Out	Track A2 with UL level			✓
9	UA0+	RS422	Out	Reference track positive	✓		
	SSI_Data+	RS422	Out	SSI data positive		✓	
10	0 V	0 V	-	Reference potential / inner shield	✓	✓	✓
11	UA0-	RS422	Out	Reference track negative	✓		
	SSI_Data-	RS422	Out	SSI data negative		✓	
12	UA1+	RS422	Out	Track A1 positive	✓		
13	UA1-	RS422	Out	Track A1 negative	✓		
14	UA2+	RS422	Out	Track A2 positive	✓		
15	UA2-	RS422	Out	Track A2 negative	✓		
Connector housing	-	-	-	Overall shield			

Tab. 7-3: Pin assignment

Technical data [chapter 8.2 "EM - encoder emulation" on page 110](#)

Optional connection points

7.4 X22 P2, X23 P1, Multi-Ethernet (ET option)

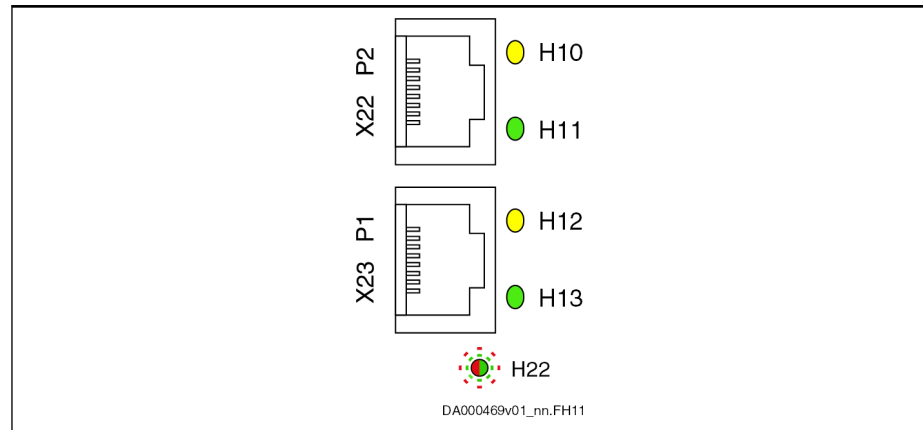

Tab. 7-4: Connection point

Technical data [chapter 6.4 "X24 P2, X25 P1, communication" on page 52](#)

7.5 X26, Engineering interface (EP option)

See [chapter 6.5 "X26, Engineering interface"](#) on page 54.

Optional connection points

7.6 X30, PROFIBUS PB

Description

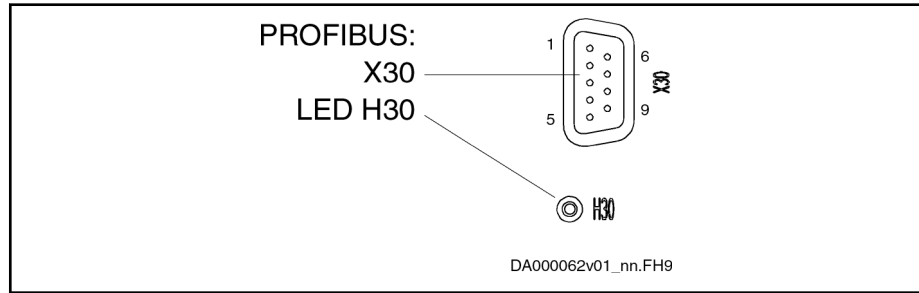

Fig. 7-1: PROFIBUS Interface

View	Identification	Function	
	X30	PROFIBUS PB	
D-Sub, 9-pin, female			
Connection cable		Unit	Min.
Stranded wire		mm ²	0.08
		Max.	0.5

Tab. 7-5: Function, pin assignment, properties

Pin assignment

Pin	DIR	Signal	Function
1		-	n. c.
2		-	n. c.
3	I/O	RS485+	Receive/transmit data-positive
4	O	CNTR-P	Repeater control signal
5		0 V	0 V
6	O	+5 V	Repeater supply
7		-	n. c.
8	I/O	RS485-	Receive/transmit data-negative
9		0V	0 V

Tab. 7-6: Signal assignment

Shield Connection

Via D-sub mounting screws and metallized connector housing.

Compatibility of the Interface

According to DIN EN 50 170

Recommended Cable Type

According to DIN EN 50 170 - 2, cable type A

Bus Connectors

The PROFIBUS connectors each have a connectable terminating resistor. The terminating resistor must always be active at both the first and last bus node. Carry out the connection as shown in the figures below.

Optional connection points

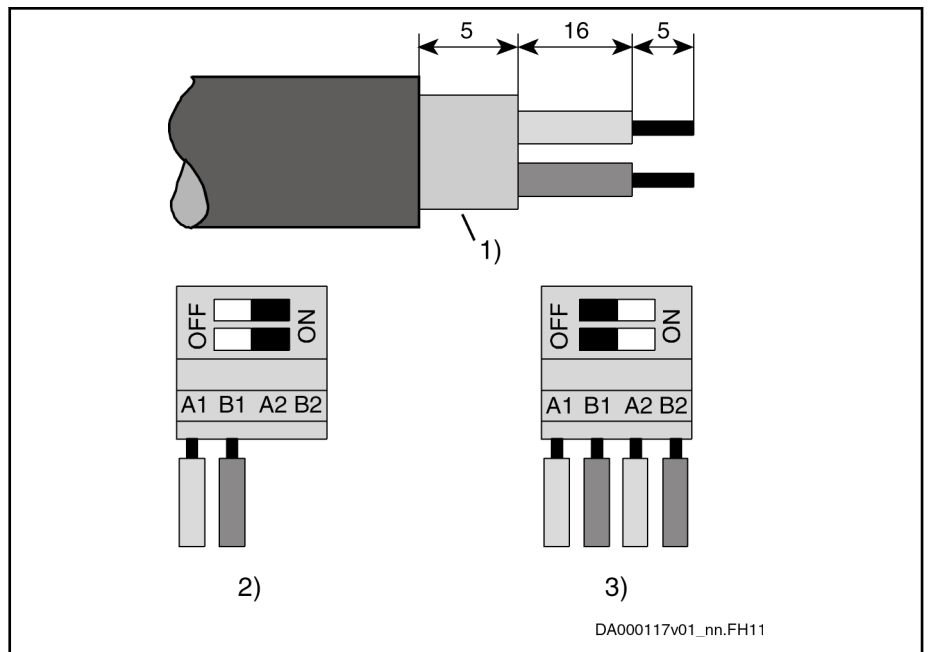

- 1) Shield
- 2) Bus connection and switch position for first node and last node
- 3) Bus connection and switch position for all other nodes

Fig. 7-2: Preparing a Cable for Connecting a Bus Connector

To assemble the bus cable, proceed as follows:

- Use cable according to DIN EN50170 / 2 edition 1996
- Strip cable (see figure above)
- Insert both cores into screw terminal block



Do not interchange the cores for A and B.

- Press cable sheath between both clamps
- Screw on both cores in screw terminals

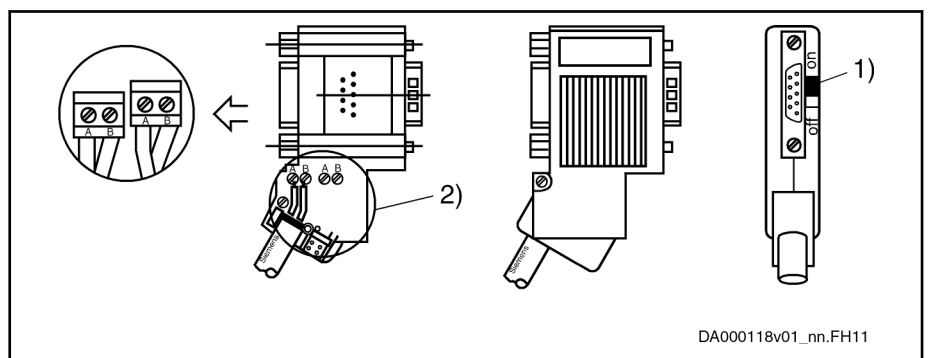

- 1) Switch position for first slave and last slave in PROFIBUS-DP
- 2) Cable shield must have direct contact to metal

Fig. 7-3: Bus Connection for First and Last Slave, Bus Connector With 9-pin D-Sub Female Connector, INS0541

Optional connection points

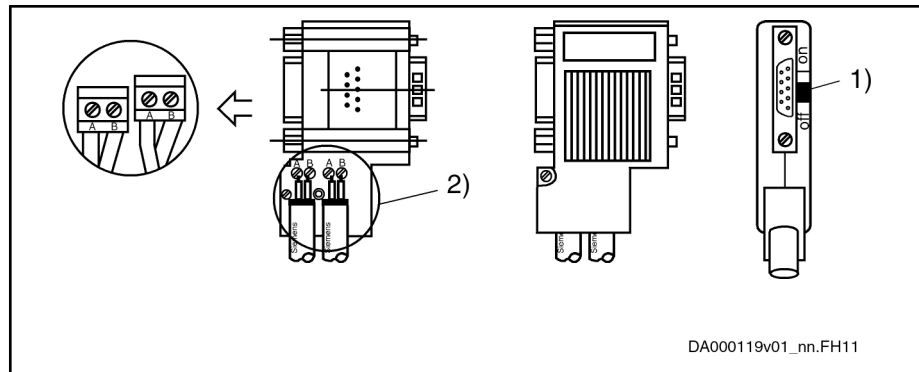

- 1) Terminating resistor is off
- 2) Cable shield must have direct contact to metal

Fig. 7-4: Bus Connection for all Other Slaves, Bus Connector With 9-pin D-Sub Female Connector, INS0541

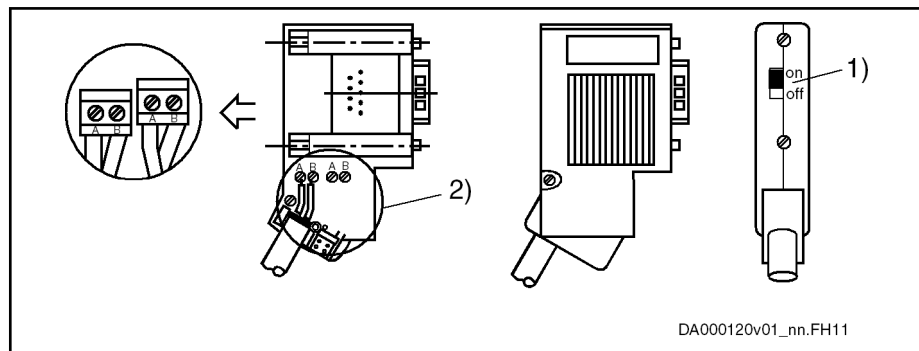

- 1) Switch position for first slave and last slave in PROFIBUS-DP
- 2) Cable shield must have direct contact to metal

Fig. 7-5: Bus Connection for First and Last Slave, Without 9-pin D-Sub Female Connector, INS0540

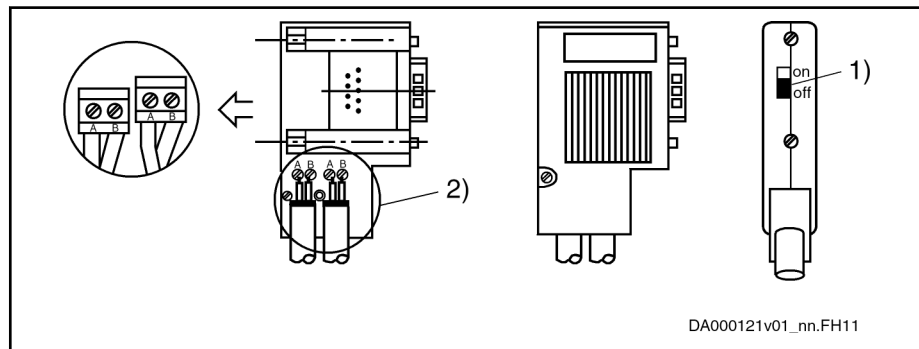

- 1) Terminating resistor is off
- 2) Cable shield must have direct contact to metal

Fig. 7-6: Bus Connection for all Other Slaves, Without 9-pin D-Sub Female Connector, INS0540

Connect the drive controller to a control unit using a shielded two-wire line in accordance with DIN 19245/Part 1.

Signal Specification [chapter 8.4 "PB - PROFIBUS" on page 122](#)

7.7 X37, digital inputs/outputs (DA option)

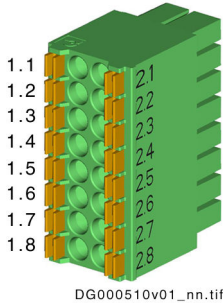
View	Connection	Signal name	Function	Connection	Signal name	Function
	1.1	I_3	Digital input	2.1	IO_1	Digital input/output
	1.2	I_4		2.2	IO_2	
	1.3	I_5		2.3	O_3	Digital output
	1.4	I_6		2.4	O_4	
	1.5	I_7	2.5	O_5		
	1.6	I_8	2.6	O_6		
	1.7	24V_Ext	Power supply (U _{ext})	2.7	O_7	
	1.8	0V_Ext		2.8	O_8	
	Spring terminal (connector)	Unit	Min.	Max.		
Connection cable	mm ²	0,2	1,5			
	AWG	24	16			
Stripped length	mm	-	10			

Tab. 7-7: Function, pin assignment, properties

- Technical data**
- [chapter "Digital inputs type A \(standard\)" on page 126](#)
 - [chapter "Digital outputs \(standard\)" on page 130](#)

Optional connection points

7.8 X38, analog inputs/outputs (DA option)

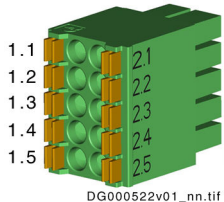
View	Connection	Signal name	Function	Connection	Signal name	Function
	1.1	GND_AnaEA	GND reference	2.1	IA_2+	Analog differential input
	1.2	OA_1	Analog output	2.2	IA_2-	
	1.3	GND_100_An aOut	Connection for inner cable shield	2.3	GND_100_An aIn	Connection for inner cable shield
	1.4	OA_2	Analog output	2.4	IA_1+	Analog differential input
	1.5	GND_AnaEA	GND reference	2.5	IA_1-	
Spring terminal (connector)	Unit	min.				max.
Connection cable Stranded wire	mm ²	0.2				1.5
	AWG	24				16
Stripped length	mm	-				10

Tab. 7-8: Function, pin assignment, properties

Shield connection [chapter 9.3 "Analog inputs/outputs: Shield connection" on page 142](#)

- Technical data**
- [chapter 8.8 "Analog voltage input" on page 134](#)
 - [chapter 8.9 "Analog current input" on page 135](#)
 - [chapter 8.10 "Analog output" on page 136](#)

7.9 X41, Safe Motion safety technology (S4, S5 options)

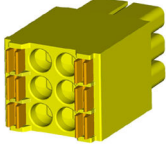
View	Connection	Signal name	Function
	1.1	SI_Out_Ch2	Safe output channel 2
	1.2	0V	Power supply of inputs/outputs (U_{ext})
	1.3	SI_Out_Ch1	Safe output channel 1
	2.1	SI_In_Ch2	Input 2
	2.2	24V	Power supply of inputs/outputs (U_{ext})
	2.3	SI_In_Ch1	Input 1
Spring terminal (connector)	Unit	min.	max.
Connection cable Stranded wire	mm ²	0.25	1.5
	AWG	24	16
Stripped length	mm	-	10
Polarity reversal protection for power supply	-	Present	
Overvoltage protection	-	Present	

Tab. 7-9: X41, Safe Motion safety technology

Technical data [chapter "Digital inputs \(safety technology S options\)" on page 129](#)
[chapter "Digital outputs \(safety technology S options\)" on page 132](#)

7.10 X41.1, X41.2, Safe Motion safety technology (S4, S5 options)

Assignment X41.1: Axis 1
 X41.2: Axis 2

Pin assignment [chapter 7.9 "X41, Safe Motion safety technology \(S4, S5 options\)" on page 75](#)

Optional connection points

7.11 X42, X43, Safe Motion safety technology (communication; S4, S5 options)

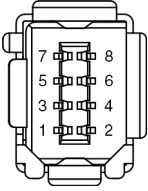
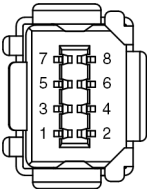
View	Identification	Function
 <p>X42:</p>  <p>X43:</p>	<p>X42 X43</p>	<p>Connection points for connecting the HSZ01¹⁾ safety zone module and the safety zone nodes:</p> <p>X42: Input X43: Output</p>
<p>Connection cable</p>		<ul style="list-style-type: none"> • Maximum total length of all cables of a safety zone: 2500 m • Maximum length of one cable between two connection points: 100 m • Number of safety zone nodes (without HSZ01): <ul style="list-style-type: none"> – Maximum: 35 – Minimum: 1 • Ready-made cables that can be ordered: <ul style="list-style-type: none"> – RKB0061 Short cables to connect devices arranged side by side in the control cabinet. Available lengths: 0.25 m; 0.35 m; 0.55 m Minimum bending radius with permanent routing: 4xD (= 4x6.3 mm = 25.2 mm) Minimum bending radius with flexible routing: 8xD (= 8x6.3 mm = 50.4 mm) Order code for a 0.55 m long cable: RKB0061/00,55 – RKB0062 Long cables to connect remote communication nodes, also outside of the control cabinet. Available lengths: 1 m, 2 m, 3 m, ... 15 m, 20 m, 30 m, 50 m, 75 m, 100 m Minimum bending radius with permanent routing: 4xD (= 4x6.3 mm = 25.2 mm) Minimum bending radius with flexible routing: 8xD (= 8x6.3 mm = 50.4 mm) Order code for a 5 m long cable: RKB0062/005,0 <p>The cables RKB0061 and RKB0062 replace the previously used cables RKB0051 and RKB0052.</p>

1) See Project Planning Manual "IndraDrive Additional Components and Accessories" (R911306140).

Tab. 7-10: X42, X43

7.12 X42.1, X42.2, X43.1, X43.2, Safe Motion safety technology (communication; S4, S5 options)

Assignment X42.1, X43.1: Axis 1
X42.2, X43.2: Axis 2

Data [chapter 7.11 "X42, X43, Safe Motion safety technology \(communication; S4, S5 options\)" on page 76](#)

Optional connection points

7.13 X48, SBC safety technology (S4, S5, SB options)

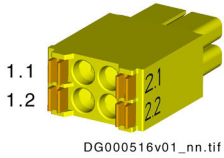
View	Connection	Signal name	Function
	1.1	Ext_SI_bSBC_Ch2	Channel 2 brake control output
	1.2	Ext_Diag_I_Brake	Channel 1 and channel 2 diagnostic input
	2.1	Ext_SI_bSBC_Ch1	Channel 1 brake control output
	2.2	-	n. c.

Tab. 7-11: Pin assignment

Mechanical data

Spring terminal (connector)	Unit	min.	max.
Connection cable	mm ²	0.25	1.5
Stranded wire	AWG	24	16
Stripped length	mm	-	10

Tab. 7-12: Mechanical data



- The power is supplied via X33.
- "SBC safety technology" additionally requires an external HAT02 control module.

7.14 X48.1, X48.2, SBC safety technology (S4, S5, SB options)

Assignment X48.1: Axis 1
X48.2: Axis 2

Pin assignment [chapter 7.13 "X48, SBC safety technology \(S4, S5, SB options\)" on page 78](#)



"SBC safety technology" additionally requires an external HAT02 control module.

7.15 X49, optional safety technology Safe Torque Off (L3 option)

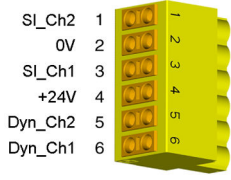
View	Connection	Signal name	Function
 <p>SI_Ch2 1 0V 2 SI_Ch1 3 +24V 4 Dyn_Ch2 5 Dyn_Ch1 6</p>	1	SI_Ch2	Input for selection of channel 2
	2	0V	GND reference of inputs and outputs
	3	SI_Ch1	Input for selection of channel 1
	4	+24V	Dynamization outputs power supply
	5	Dyn_Ch2	Channel 2 dynamization output
	6	Dyn_Ch1	Channel 1 dynamization output
Spring terminal (connector)	Unit	min.	max.
Connection cable	mm ²	0.25	1.5
	AWG	24	16
Stranded wire			
Stripped length	mm	-	8

Tab. 7-13: X49, optional safety technology Safe Torque Off



If the dynamization outputs do not work, check the power supply connection. The polarity might have been reversed.

Technical data [chapter "Digital inputs \(safety technology L options\)" on page 128](#)
[chapter "Digital outputs \(safety technology L options\)" on page 131](#)

7.16 X49.1, X49.2, optional safety technology Safe Torque Off (L3 option)

Assignment X49.1: Axis 1
 X49.2: Axis 2

Pin assignment [chapter 7.15 "X49, optional safety technology Safe Torque Off \(L3 option\)" on page 79](#)

Optional connection points

7.17 X61, CANopen (CN Option)

Description

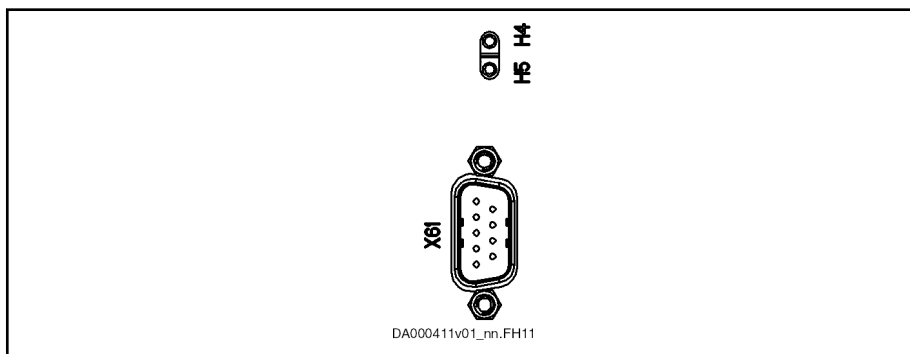

Fig. 7-7: CANopen

Connection Point

Connection point	Type	Number of poles	Type of design	Stranded wire [mm ²]	Figure
X61	D-Sub	9	Pins on device	0,25–0,5	

Tab. 7-14: Connection point

Pin Assignment

Pin	Signal	Function
1	n. c.	-
2	CAN-L	Negated CAN signal (Dominant Low)
3	CAN-GND	Reference potential of CAN signals
4	n. c.	-
5	Drain/Shield	Shield connection
6	GND	Reference potential of device
7	CAN-H	Positive CAN signal (Dominant High)
8	n. c.	-
9	n. c.	-

Tab. 7-15: Signal Assignment

Technical Data [chapter 8.5 "CN - CANopen" on page 123](#)

7.18 Control panels

7.18.1 Type code

Short type designation	1	2	3	4	5	6	7	8	9	0	1	2	3	4	5	6	7	8	9	0	1	2	3	4	5	6	7	8	9	0	1	2	3	4	5	6	7	8	9	0					
Example:	H	A	P	0	1	.	1	N	-	0	1	8	-	N	N	-	F	W																											
	①	②	③	④	⑤	⑥	⑦																																						
①	Product: HAP = Control panel																																												
②	Series: 01 = 01																																												
③	Design: 1 = 1																																												
④	Additional option: A = ADVANCED control panel with memory card slot N = Standard control panel without memory card slot																																												
⑤	Memory size: 018 = 18 MB (example)																																												
⑥	Other design: NN = None																																												
⑦	Firmware: FW = Firmware must be ordered as a separate subposition																																												

Tab. 7-16: HAP01 type code

Optional connection points

7.18.2 ADVANCED Control Panel HAP01.1A



For a detailed description of the control panel, see the documentation "Application Manual, Functions" of the firmware used.

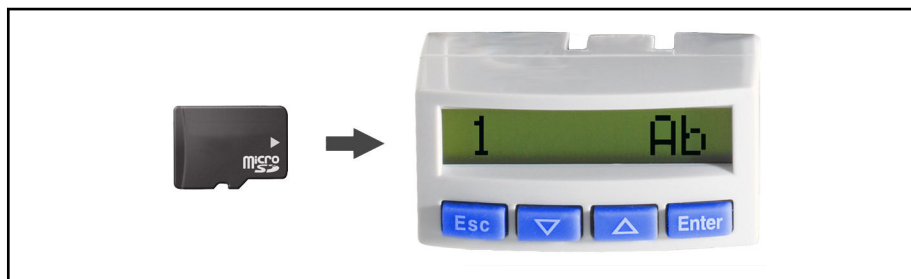

Fig. 7-8: ADVANCED Control Panel HAP01.1A

Description

The ADVANCED control panel HAP01.1A

- has a slot for a **microSD** memory card (PFM04.1)
- has a single-line display
- is suited for hot plug
- can be used as programming module
- The **display** shows operating states, command and error diagnoses and pending warnings.
- Using the four **keys**, the commissioning engineer or service technician can have extended diagnoses displayed and trigger simple commands.
- Memory:
 - 2 MB (data, flash memory)
 - 16 MB (code, flash memory)
 - 32 kB (retain data, FRAM memory)

7.18.3 Standard control panel HAP01.1N



For a detailed description of the control panel, see the documentation "Application Manual, Functions" of the firmware used.



Fig. 7-9: Standard control panel HAP01.1N

Description

The standard control panel

- has a single-line display
- must have been plugged in when the drive controller is switched on so that it can be recognized (not suited for hot plug)
- can be used as programming module
- The **display** shows operating states, command and error diagnoses and pending warnings.
- Using the four **keys**, the commissioning engineer or service technician can have extended diagnoses displayed and trigger simple commands.
- Memory
 - 400 kbytes for MLD boot program
 - 492 bytes for MLD retain variables

8 Technical data - functions

8.1 EC - standard encoder evaluation

8.1.1 Supported encoder systems

- Supported encoder systems** Encoder systems with a supply voltage of 5 and 12 V:
- MSM motor encoder
 - MSK motor encoder
 - MS2N motor encoder
 - 1V_{pp} sin-cos encoder; HIPERFACE®
 - 1V_{pp} sin-cos encoder; EnDat 2.1
 - 1V_{pp} sin-cos encoder; with reference track
 - 5V-TTL square-wave encoder; with reference track
 - SSI
 - Combined encoder for SSI (combination of SSI and 1V_{pp} sin-cos encoder)
 - EnDat 2.2
 - Resolver (resolvers are **not** supported if an optional S4 safety technology is available at the same time.)
 - SHL02.1 Hall sensor box
 - Digital Hall sensor in conjunction with SHL03.1 Hall sensor adapter box

Technical data - functions

8.1.2 Encoder type

IndraDyn S MSM motors (5V supply voltage)

Properties Encoder systems of the MSM motors are digital encoder systems that can be evaluated in absolute form.

Connection diagram

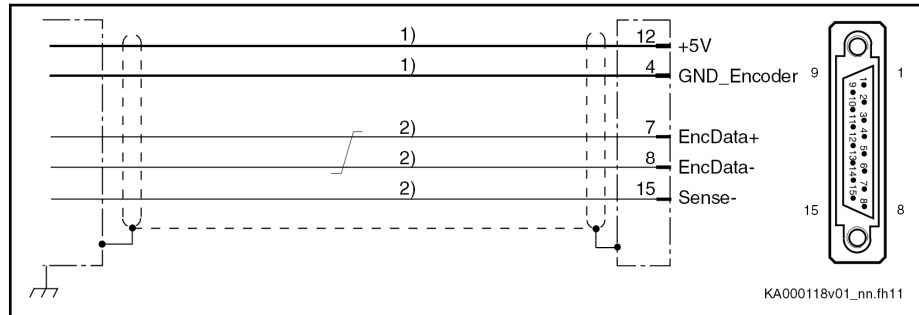

1) Line cross section $\geq 0.5 \text{ mm}^2$; observe allowed encoder cable length

2) Line cross section $\geq 0.14 \text{ mm}^2$

Fig. 8-1: EC connection diagram with encoder system of IndraDyn S MSM motors



For **direct** connection to the encoder system, use our **RKG0033** or **RKG0062** cable.

Power supply 5 V (the voltage is made available via the EC interface)

Technical specification of the power supply: See [chapter "5 V power supply" on page 102](#)

Cable length 40 m at most

IndraDyn S MSK/QSK motors S1/M1, S2/M2, S3/M3, S5/M5 (12 V supply voltage)

Properties Encoder systems of the MSK/QSK motors are HIPERFACE® (S1/M1, S3/M3, S5/M5) or EnDat 2.1 (S2/M2) encoder systems.

The type code of the motor shows whether or not the encoder system supports the single-turn (Sx) or multi-turn (Mx) functionality. Example: The MSK050C-0600-NN-S1-UG0-NNNN motor has a single-turn HIPERFACE® encoder system.

Connection diagram

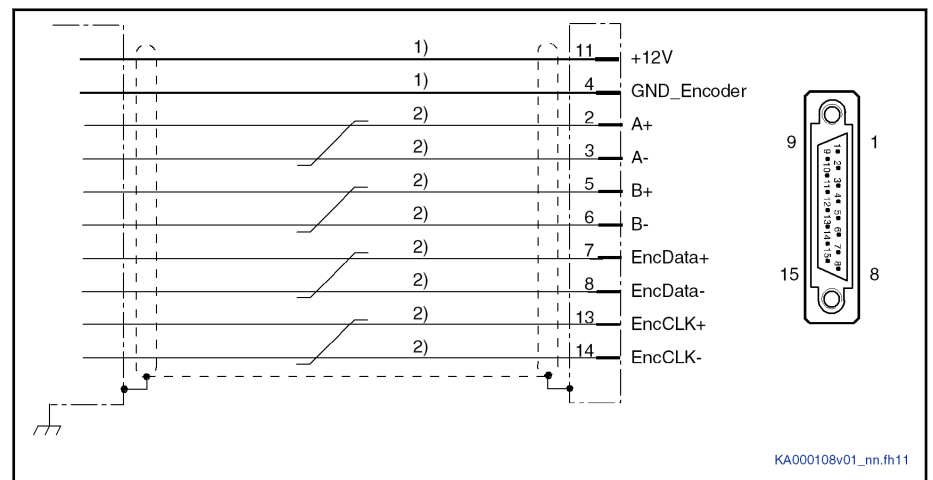

- 1) Line cross section $\geq 0.5 \text{ mm}^2$; observe allowed encoder cable length
- 2) Line cross section $\geq 0.14 \text{ mm}^2$

Fig. 8-2: MSK/QSK encoder interface connection diagram for S1/M1, S2/M2, S5/M5 encoder systems



For **direct** connection to the encoder system, use our **RKG4200** cable.

- Power supply** 12 V (the voltage is made available via the EC interface)
 Technical specification of the power supply: See [chapter "12 V power supply" on page 102](#)
- Cable length** The maximum allowed cable length depends on several factors: See [chapter 8.1.4 "Encoder cable length" on page 104](#)

Technical data - functions

IndraDyn S MS2N motors AS/AM, BS/BM, CS/CM, HS/HM, DS/DM (12 V supply voltage)

Properties Encoder systems of the MS2N motors are HIPERFACE® (AS/AM, BS/BM) or ACURO®link (CS/CM, HS/HM, DS/DM) encoder systems.

The type code of the motor shows whether or not the encoder system supports the single-turn (xS) or multi-turn (xM) functionality. Example: The MS2N04-D0BHN-**CS**DH0-NNNN-NN motor has a single-turn ACURO®link encoder system.

Connection diagram

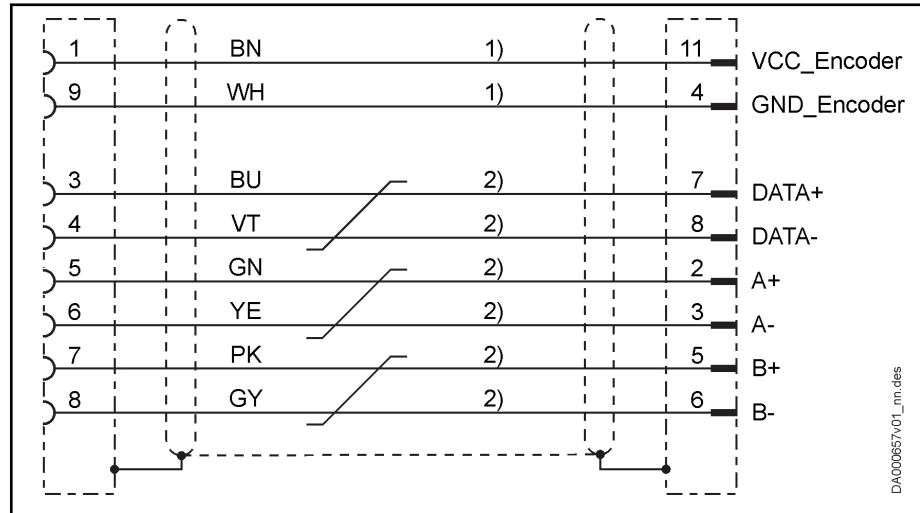

- 1) Line cross section $\geq 0.5 \text{ mm}^2$; observe allowed encoder cable length
- 2) Line cross section $\geq 0.25 \text{ mm}^2$

Fig. 8-3: MS2N encoder interface connection diagram for AS/AM, BS/BM encoder systems (RG2-002AB... encoder cable)

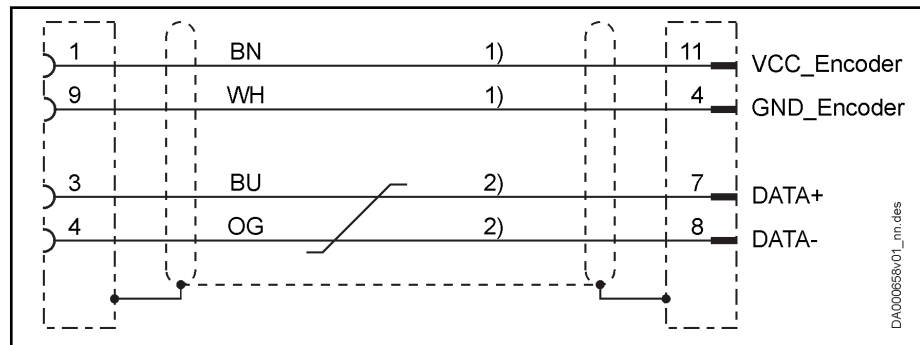

- 1) Line cross section $\geq 0.5 \text{ mm}^2$; observe allowed encoder cable length
- 2) Line cross section $\geq 0.2 \text{ mm}^2$

Fig. 8-4: MS2N encoder interface connection diagram for CS/CM, HS/HM, DS/DM encoder systems (RG2-002AA... encoder cable)



Encoder cables:

- **HIPERFACE® (AS/AM, BS/BM):**
For **direct** connection to the encoder system, use our **RG2-002AB** cable.
 - **ACURO®link (CS/CM, HS/HM, DS/DM):**
For **direct** connection to the encoder system, use our **RG2-002AA** cable.
-

Power supply	12 V (the voltage is made available via the EC interface) Technical specification of the power supply: See chapter "12 V power supply" on page 102
Cable length	The maximum allowed cable length depends on several factors: See chapter 8.1.4 "Encoder cable length" on page 104

Technical data - functions

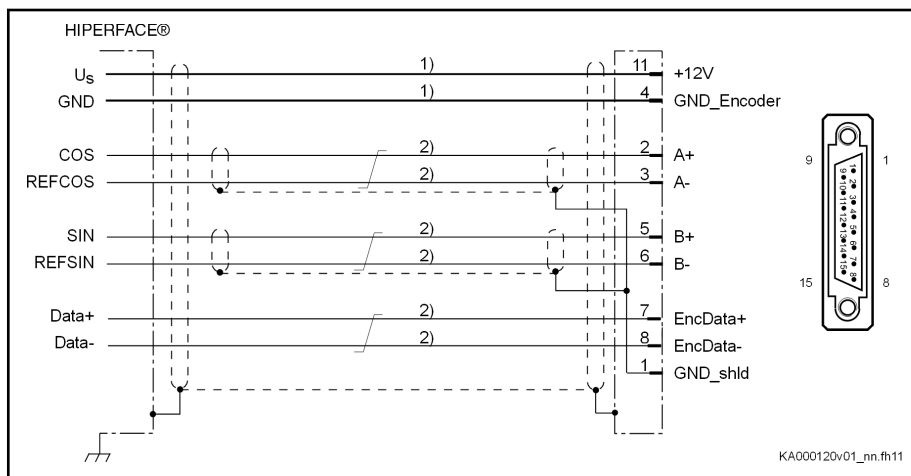
HIPERFACE® (12 V supply voltage)**Connection diagram**

1) Line cross section $\geq 0.5 \text{ mm}^2$; observe allowed encoder cable length

2) Line cross section $\geq 0.14 \text{ mm}^2$

Fig. 8-5: HIPERFACE® encoder system connection diagram

Power supply The HIPERFACE® encoder system needs a supply voltage of 12 V. This supply voltage is made available via the EC interface.

Technical specification of the power supply: See [chapter "12 V power supply" on page 102](#)



Please observe that the third-party encoder used has to be suited for the voltage available at the EC interface as the encoder supply voltage.

Cable length The maximum possible cable length depends on several factors: See [chapter 8.1.4 "Encoder cable length" on page 104](#)

EnDat 2.1 according to Heidenhain standard (5 V supply voltage)

Connection diagram

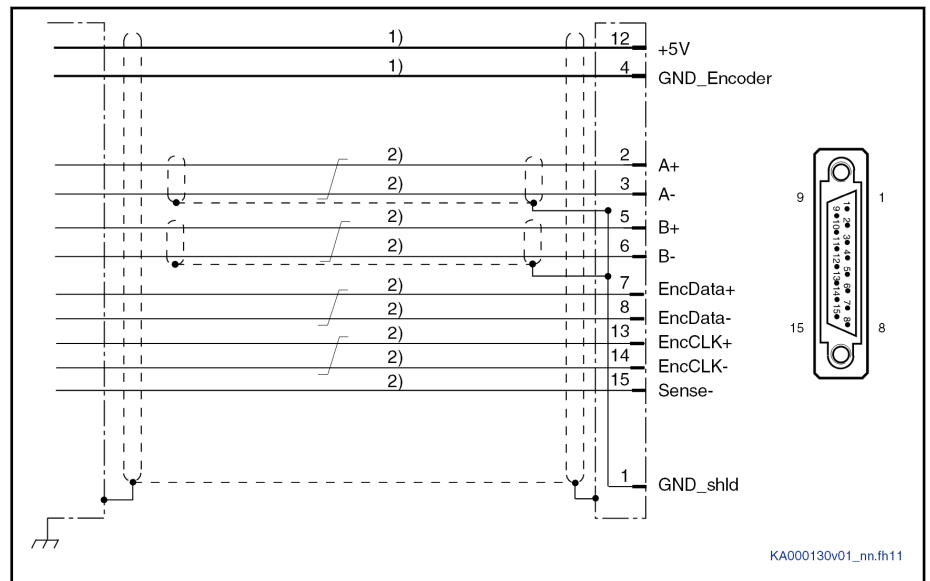

1) Line cross section $\geq 0.5 \text{ mm}^2$; observe allowed encoder cable length

2) Line cross section $\geq 0.14 \text{ mm}^2$

Fig. 8-6: EC connection diagram with EnDat 2.1 encoder system



For **direct** connection to the encoder system, use our **RKG0036** cable.

Power supply 5 V (the voltage is made available via the EC interface)

Technical specification of the power supply: See [chapter "5 V power supply" on page 102](#)

Cable Length 75 m at most (when using the Sense function)

When you do not use the Sense function, the maximum cable length is reduced (see [chapter 8.1.4 "Encoder cable length" on page 104](#)).

Technical properties Use the Sense function to ensure stable power supply at the encoder. Description of the Sense function: See [chapter "5 V power supply" on page 102](#)

Technical data - functions

EnDat 2.2 according to Heidenhain standard (5 V supply voltage)

Connection diagram

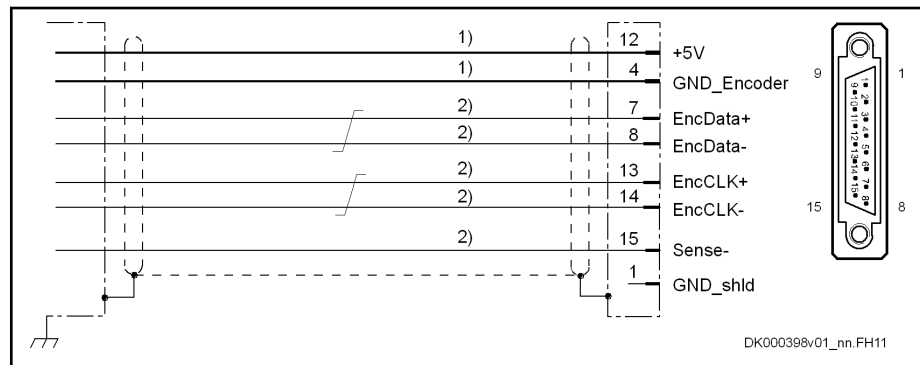

- 1) Line cross section $\geq 0.5 \text{ mm}^2$; observe allowed encoder cable length
- 2) Line cross section $\geq 0.14 \text{ mm}^2$

Fig. 8-7: EnDat 2.2 encoder system connection diagram

Power supply 5 V (the voltage is made available via the EC interface)Technical specification of the power supply: See [chapter "5 V power supply" on page 102](#)**Cables** Only use Heidenhain cables.

If you have any questions on the cables or specific applications (e.g., using adapters), please contact Heidenhain directly.

Cable Length 75 m at most (when using the Sense function)When you do not use the Sense function, the maximum cable length is reduced (see [chapter 8.1.4 "Encoder cable length" on page 104](#)).**Technical properties** Use the Sense function to ensure stable power supply at the encoder. Description of the Sense function: See [chapter 8.1.4 "Encoder cable length" on page 104](#)

1V_{pp} according to Heidenhain standard (5 V supply voltage)

Connection diagram

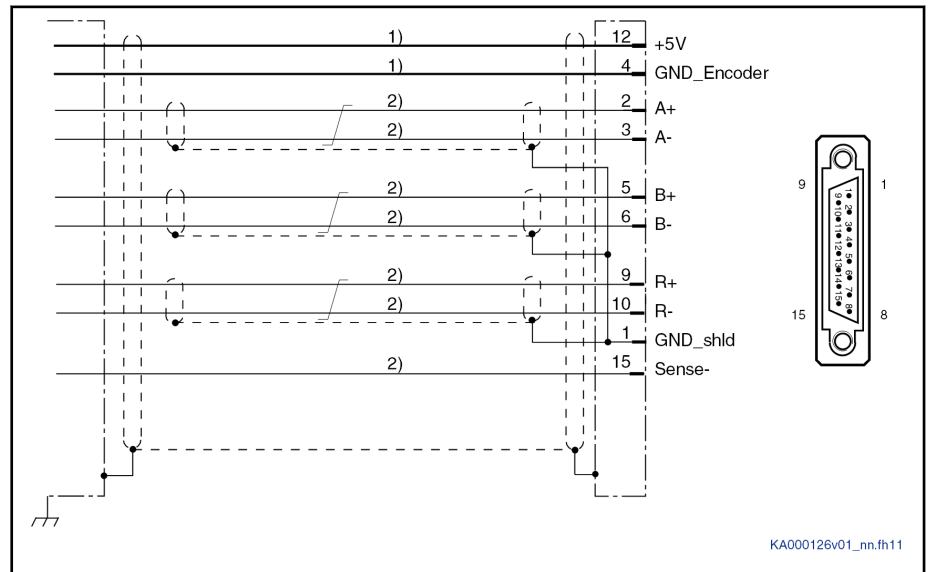

1) Line cross section $\geq 0.5 \text{ mm}^2$; observe allowed encoder cable length

2) Line cross section $\geq 0.14 \text{ mm}^2$

Fig. 8-8: EC connection diagram with 1V_{pp} encoder system



For **direct** connection to the encoder system, use our **RKG0035** cable.

Power supply 5 V (the voltage is made available via the EC interface)

Technical specification of the power supply: See [chapter "5 V power supply" on page 102](#)

Cable Length 75 m at most (when using the Sense function)

When you do not use the Sense function, the maximum cable length is reduced (see [chapter 8.1.4 "Encoder cable length" on page 104](#)).

Technical properties Use the Sense function to ensure stable power supply at the encoder. Description of the Sense function: See [chapter "5 V power supply" on page 102](#)

Technical data - functions

1V_{pp} (12 V supply voltage)

Connection diagram

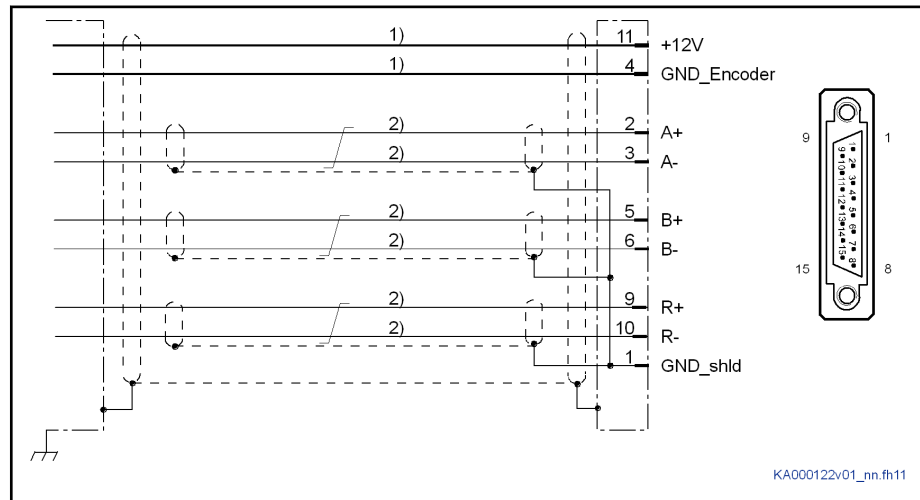

1) Line cross section $\geq 0.5 \text{ mm}^2$; observe allowed encoder cable length

2) Line cross section $\geq 0.14 \text{ mm}^2$

Fig. 8-9: 1V_{pp} encoder system connection diagram

Power supply 12 V (the voltage is made available via the EC interface)

Technical specification of the power supply: See [chapter "12 V power supply" on page 102](#)

Cable length The maximum allowed cable length depends on several factors: See [chapter 8.1.4 "Encoder cable length" on page 104](#)

TTL (5 V supply voltage)

Connection diagram

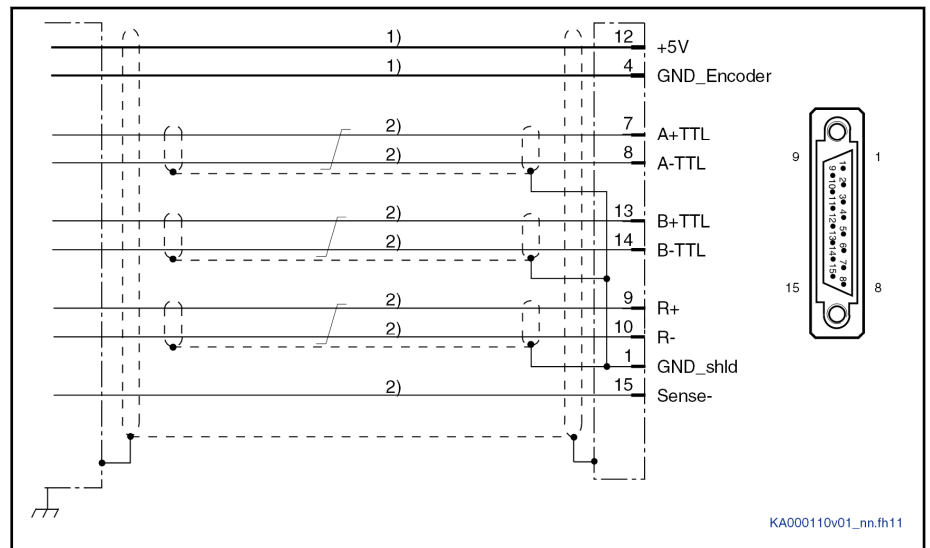

- 1) Line cross section $\geq 0.5 \text{ mm}^2$; observe allowed encoder cable length
- 2) Line cross section $\geq 0.14 \text{ mm}^2$

Fig. 8-10: EC connection diagram with TTL encoder system

Power supply 5 V (the voltage is made available via the EC interface)

Technical specification of the power supply: See [chapter "5 V power supply" on page 102](#)

Cable Length 75 m at most (when using the Sense function)

When you do not use the Sense function, the maximum cable length is reduced (see [chapter 8.1.4 "Encoder cable length" on page 104](#)).

Technical properties Use the Sense function to ensure stable power supply at the encoder. Description of the Sense function: See [chapter "5 V power supply" on page 102](#)

Technical data - functions

TTL (12 V supply voltage)

Connection diagram

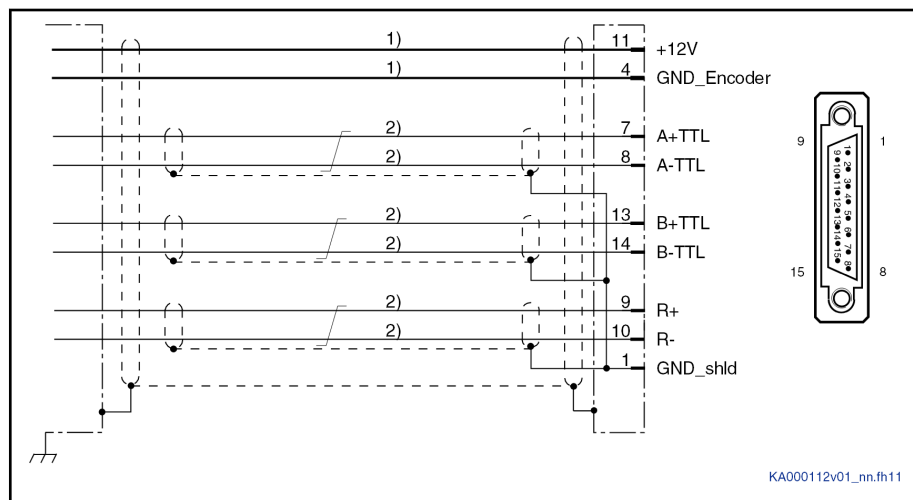

1) Line cross section $\geq 0.5 \text{ mm}^2$; observe allowed encoder cable length

2) Line cross section $\geq 0.14 \text{ mm}^2$

Fig. 8-11: TTL encoder system connection diagram

Power supply 12 V (the voltage is made available via the EC interface)

Technical specification of the power supply: See [chapter "12 V power supply" on page 102](#)

Cable length The maximum allowed cable length depends on several factors: See [chapter 8.1.4 "Encoder cable length" on page 104](#)

SSI (5 V supply voltage)

Connection diagram

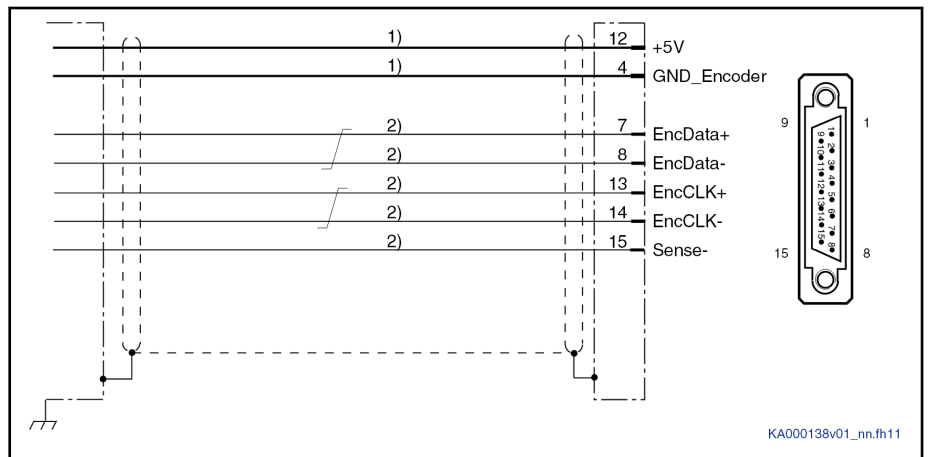

1) Line cross section $\geq 0.5 \text{ mm}^2$; observe allowed encoder cable length

2) Line cross section $\geq 0.14 \text{ mm}^2$

Fig. 8-12: EC connection diagram with SSI encoder system

Power supply 5 V (the voltage is made available via the EC interface)

Technical specification of the power supply: See [chapter "5 V power supply" on page 102](#)

Cable Length 75 m at most (when using the Sense function)

When you do not use the Sense function, the maximum cable length is reduced (see [chapter 8.1.4 "Encoder cable length" on page 104](#)).

Technical properties Use the Sense function to ensure stable power supply at the encoder. Description of the Sense function: See [chapter "5 V power supply" on page 102](#)

Technical data - functions

SSI (12 V supply voltage)

Connection diagram

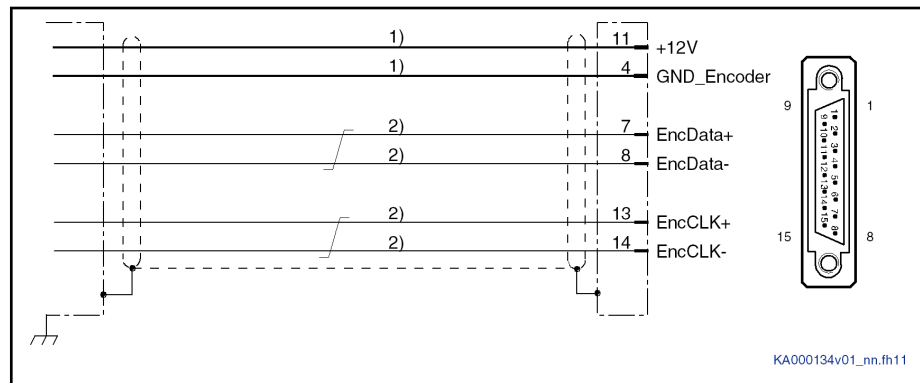

1) Line cross section $\geq 0.5 \text{ mm}^2$; observe allowed encoder cable length

2) Line cross section $\geq 0.14 \text{ mm}^2$

Fig. 8-13: SSI encoder system connection diagram

Power supply 12 V (the voltage is made available via the EC interface)

Technical specification of the power supply: See [chapter "12 V power supply" on page 102](#)

Cable length The maximum allowed cable length depends on several factors: See [chapter 8.1.4 "Encoder cable length" on page 104](#)

Combined encoder for SSI (5 V supply voltage)

The combined encoder for SSI is a combination of SSI and sin-cos encoder
 $1V_{pp}$.

Connection diagram

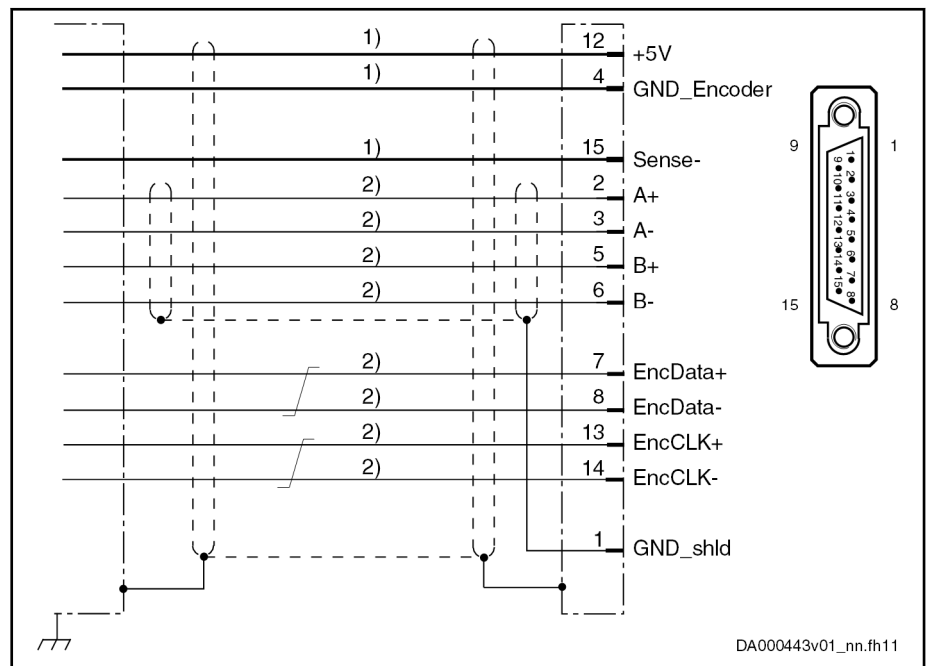

- 1) Line cross section $\geq 0.5 \text{ mm}^2$; observe allowed encoder cable length
- 2) Line cross section $\geq 0.14 \text{ mm}^2$

Fig. 8-14: EC connection diagram with SSI encoder system

- Power supply** 5 V (the voltage is made available via the EC interface)
 Technical specification of the power supply: See [chapter "5 V power supply" on page 102](#)
- Cable Length** 75 m at most (when using the Sense function)
 When you do not use the Sense function, the maximum cable length is reduced (see [chapter 8.1.4 "Encoder cable length" on page 104](#)).
- Technical properties** Use the Sense function to ensure stable power supply at the encoder.
 Description of the Sense function: See [chapter "5 V power supply" on page 102](#)

Technical data - functions

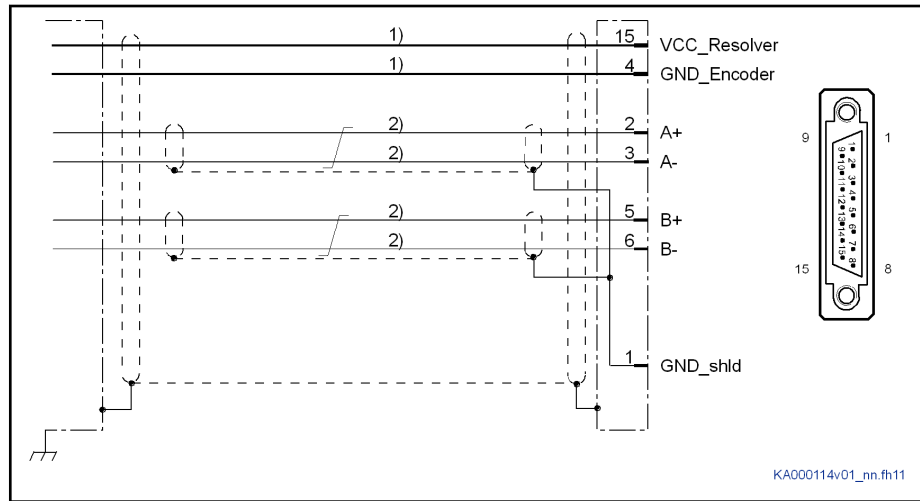
Resolvers without encoder data memory**Connection diagram**

- 1) Line cross section $\geq 0.5 \text{ mm}^2$; observe allowed encoder cable length
- 2) Line cross section $\geq 0.14 \text{ mm}^2$

Fig. 8-15: EC connection diagram with resolver encoder system

Power supply

The EC interface supplies the resolver encoder system with a carrier voltage amplitude of 11 V_{pp} .

Technical specification of the power supply: See [chapter "Resolver power supply" on page 103](#)



Please observe that the resolver encoder used has to be suited for the voltage available at the EC interface as the encoder supply voltage.

Cable length

75 m at most

Specific technical features

The encoder evaluation has been sized for resolvers with a **transfer ratio** of 0.5.

Resolvers are **not** supported if an optional S4 safety technology is available at the same time.

Hall sensor box SHL02.1 (12 V supply voltage)

Connection diagram

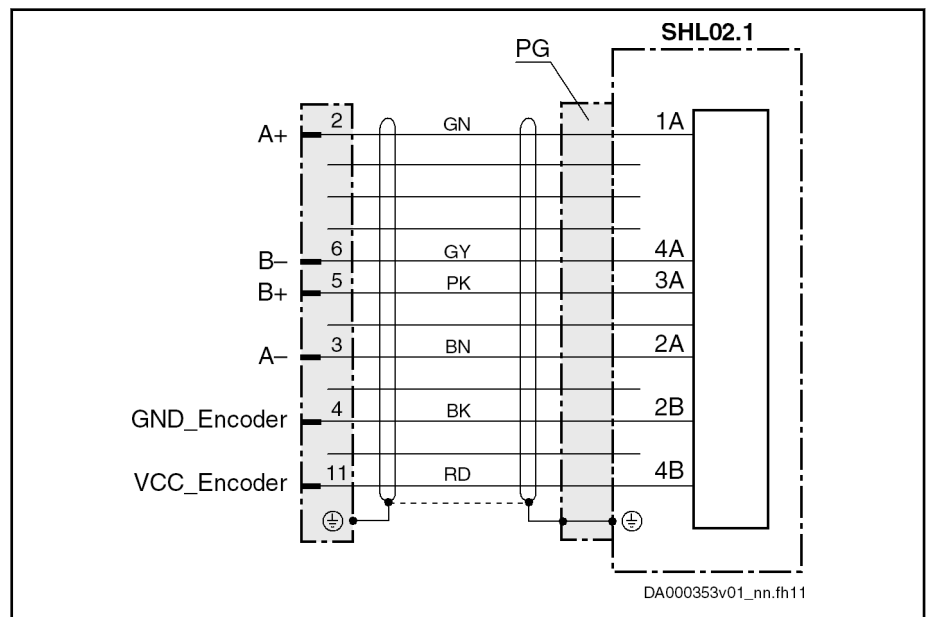

VCC_Encoder +12 V

Fig. 8-16: Hall sensor box SHL02.1 connection diagram

Power supply 12 V (the voltage is made available via the EC interface)

Technical specification of the power supply: See [chapter "12 V power supply" on page 102](#)

Cable length The maximum allowed cable length depends on several factors: See [chapter 8.1.4 "Encoder cable length" on page 104](#)

Specific technical features  For detailed information on the Hall sensor box SHL02.1, see the Functional Description "Rexroth Hall sensor box SHL02.1" (R911292537).

Technical data - functions

8.1.3 Power supply

5 V power supply

5 V power supply

Data	Unit	min.	typ.	max.
DC output voltage +5V	V	5.0		5.25
Output current	mA			500 ¹⁾

1) The sum of the power consumptions of all connected encoder systems (5 V / 12 V) should not exceed **6 W** (applies to HCS01) or **12 W** (applies to Cxx02 control sections).

Tab. 8-1: 5 V power supply

Switching off power supply via firmware

The "parking axis" firmware command (C1600) causes the encoder power supply to be switched off.

Sense function

The EC encoder evaluation allows the 5 V supply voltage at the encoder to be corrected. It is thereby possible, within certain limits, to compensate for voltage drops on the encoder cable.

Functional principle: The current consumption of the connected encoder system generates a voltage drop due to the ohmic resistance of the encoder cable (line cross section and line length). This reduces the signal at the encoder input. The actual value of the 0 V encoder potential at the encoder is measured via a separate "Sense" line (Sense-) and is fed back to the drive controller. Thus, the drive controller can influence the voltage of the encoder supply.



For correct "Sense" evaluation, the encoder supply lines "+5V" and "GND_Encoder" have to have the same line cross section.

If the encoder has a "Sense-" connection, connect the "Sense-" line at this connection. A "Sense+" connection that might exist is not used.

If the encoder has no "Sense" connection, apply the 0 V encoder potential to the "Sense-" line on the encoder side.

12 V power supply

12 V power supply

Data	Unit	min.	typ.	max.
Voltage for encoder supply	V	10.7	12	12.3
Output current	mA			500 ¹⁾

1) The sum of the power consumptions of all connected encoder systems (5 V / 12 V) should not exceed **6 W** (applies to HCS01) or **12 W** (applies to Cxx02 control sections).

Tab. 8-2: 12 V power supply

Switching off power supply via firmware

The "parking axis" firmware command (C1600) causes the encoder power supply to be switched off.

Resolver power supply

Resolver encoder system

Data	Unit	min.	typ.	max.
AC output voltage VCC_Resolver (peak-peak value)	V	8.3	10	12
Output frequency sine	kHz		8	
Output current (peak value)	mA			60 ¹⁾
Output current (rms value)	mA			40 ¹⁾

1) The sum of the power consumptions of all connected encoder systems should not exceed **6 W** (applies to HCS01) or **12 W** (applies to Cxx02 control sections).

Tab. 8-3: Resolver encoder supply

Switching off power supply via firmware

The "parking axis" firmware command (C1600) causes the encoder power supply to be switched off.

Technical data - functions

8.1.4 Encoder cable length



Use lines with the same line cross section for encoder supply.

Allowed encoder cable length for
5 V encoder systems without
Sense function

If the encoder system used does not support the Sense function, the maximum possible cable length results from the diagram below.

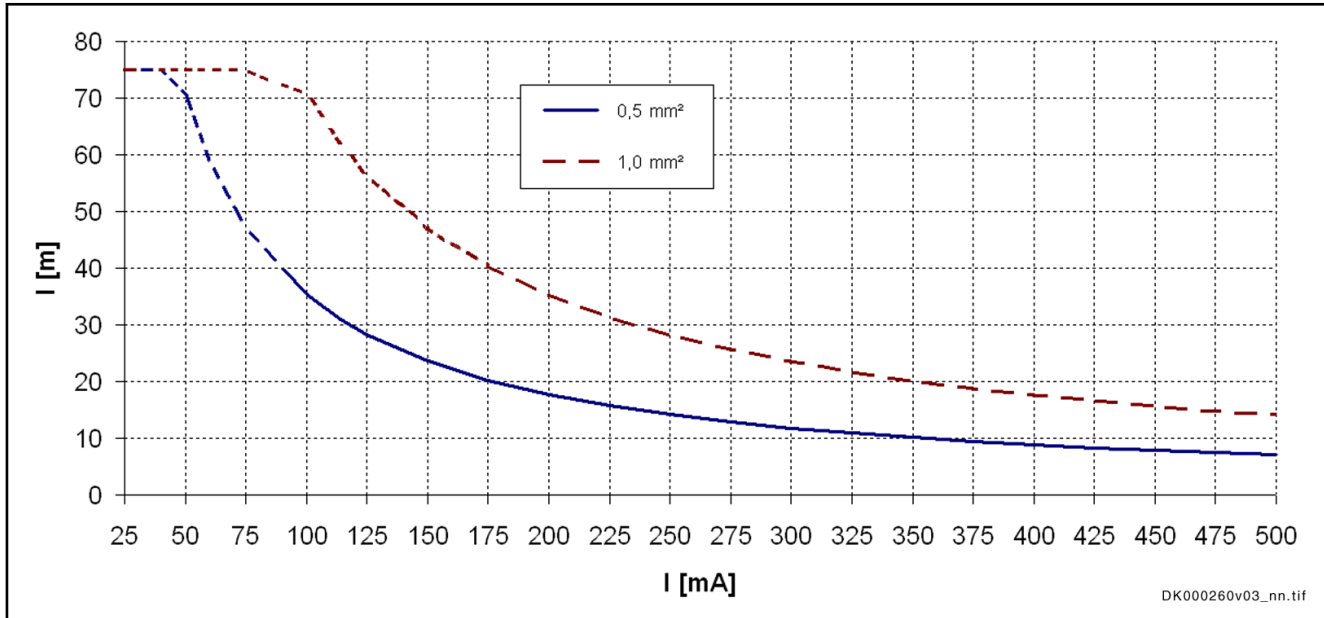

I [mA] Encoder current consumption
l [m] Cable length
0.5 mm²; 1.0 mm² Line cross sections

Fig. 8-17: Maximum allowed encoder cable lengths for 5 V encoder systems without Sense connection depending on line cross section

Allowed encoder cable length for
5 V encoder systems with Sense
function

75 m at most; (exception: 40 m at most for IndraDyn S MSM motors)
(Besides, the maximum allowed cable lengths depend on the motor size. See documentation of motor used.)

The cross section of the supply voltage lines has to be at least 0.5 mm².

Allowed encoder cable length for
12 V encoder systems

Requirements:

- The **cross section** of the supply voltage lines is at least **0.5 mm²**
- The minimum allowed **supply voltage** at the encoder is **10 V**

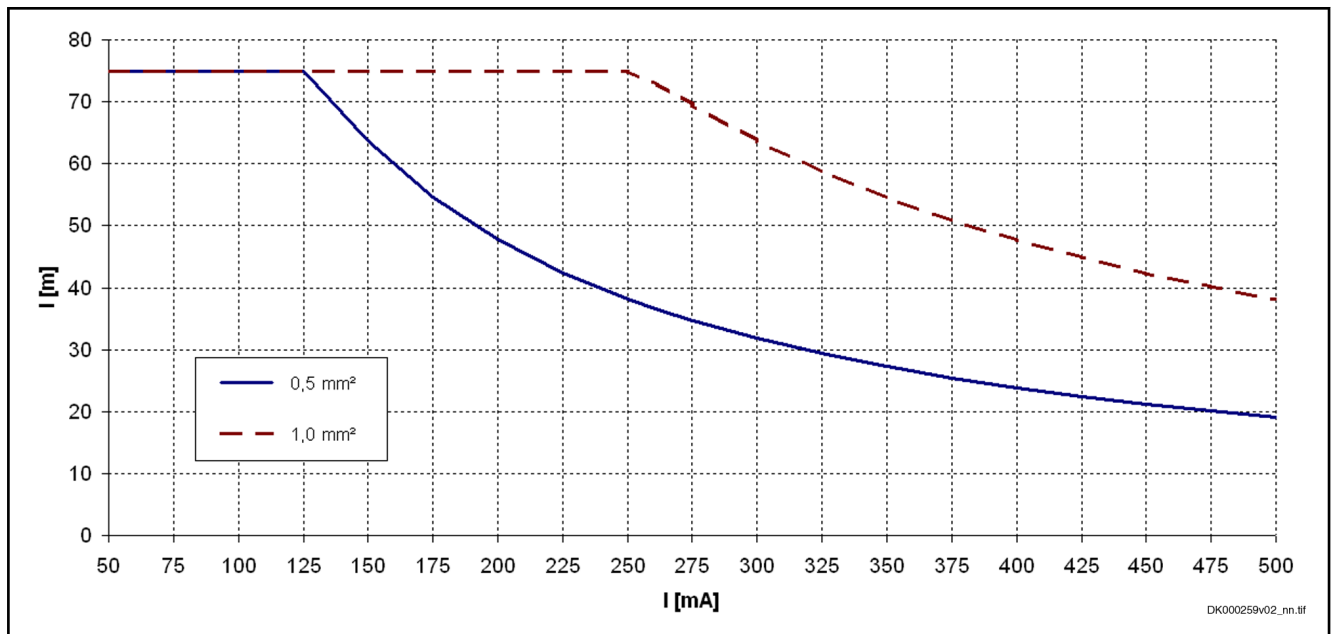

I [mA] Encoder current consumption
 l [m] Cable length
 0.5 mm²; 1.0 mm² Line cross sections

Fig. 8-18: Maximum allowed encoder cable lengths for 12 V encoder systems depending on line cross section at supply voltage of 10 V



Nominal current consumption of the MSK motor encoders: 60 mA

Allowed encoder cable length for resolver encoder systems

75 m at most (The cross section of the supply voltage lines has to be at least 0.5 mm².)

Technical data - functions

8.1.5 Technical data of EC encoder evaluation

Input circuit for sine signals A+, A-, B+, B-, R+, R-

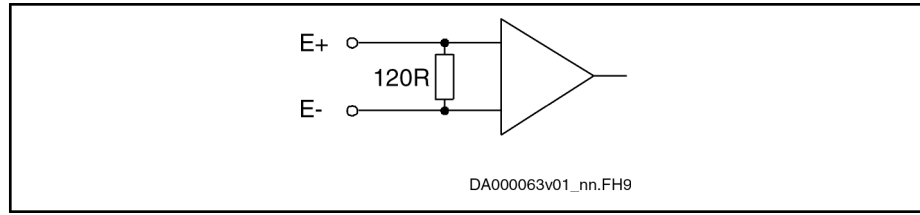

Fig. 8-19: Input circuit for sine signals (block diagram)

Properties of differential input for sine signals

Data	Unit	min.	typ.	max.
Amplitude of encoder signal peak-peak ($U_{PPencodersignal}$)	V	0.8	1.0	1.2
Cut-off frequency (-3 dB)	kHz		400	
Converter width A/D converter	Bit		12	
Input resistance	ohm		120	

Tab. 8-4: Differential input, sine

Resolver input circuit for A+, A-, B+, B-

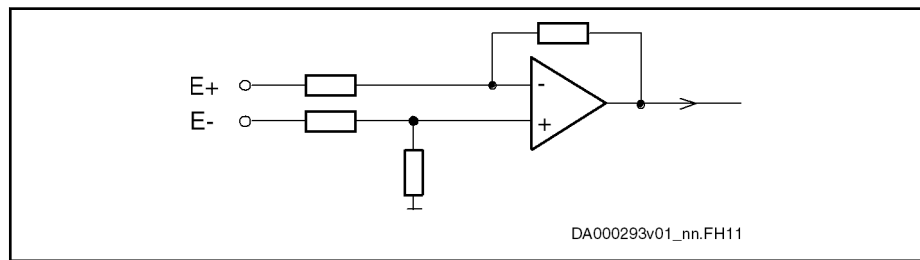

Fig. 8-20: Input circuit for resolver evaluation (block diagram)

Input circuit for square-wave signals

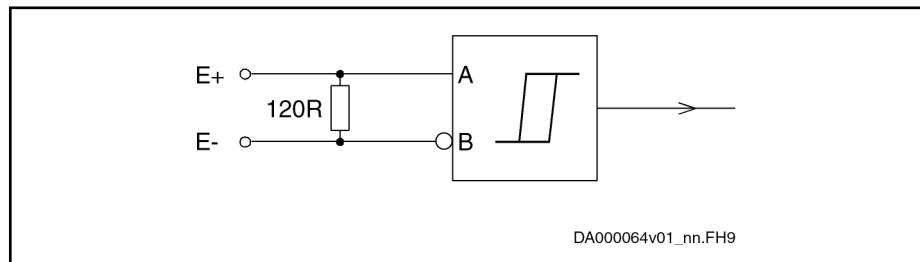

Fig. 8-21: Input circuit for square-wave signals (block diagram)

Properties of differential input for square-wave signals

Data	Unit	min.	typ.	max.
Input voltage "high"	V	2.4		5.0
Input voltage "low"	V	0		0.8
Input frequency	kHz			1000
Input resistance	ohm		120	

Tab. 8-5: Differential input, square-wave signals

Technical data - functions

Differential input for resolver operation

Data	Unit	min.	typ.	max.
Amplitude encoder signal sine (U_{pp})	V		5	6
Input resistance	kOhm		12	
Converter width A/D converter	Bit		12	

Tab. 8-6: Resolver operation input data

Technical data - functions

8.1.6 Signal assignment to the actual position value

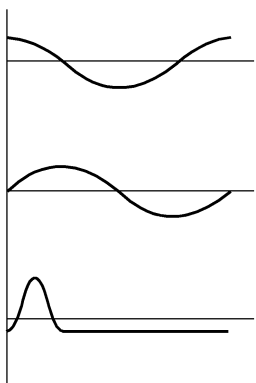
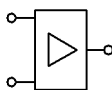
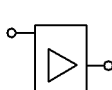
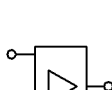
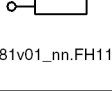
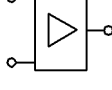
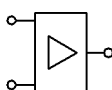
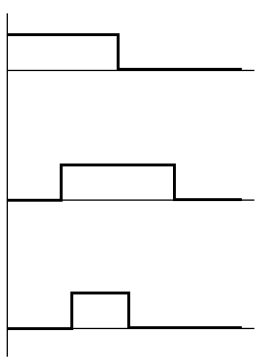
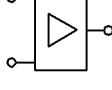
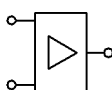
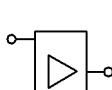
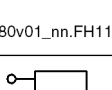
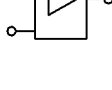
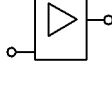
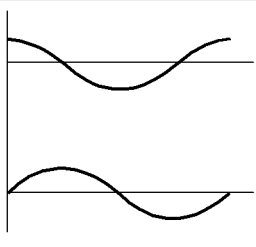
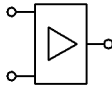
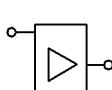
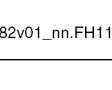
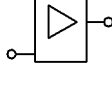
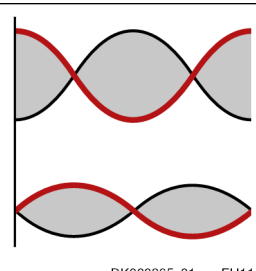
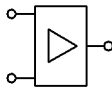
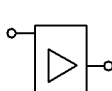
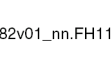
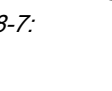
Signal assignment ¹⁾	Signal designation	Signal shape	Actual position value (with default setting)
 <p>DK000089v01_nn.FH9</p>	<p>A+ </p> <p>A- </p> <p>B+ </p> <p>B- </p> <p>R+ </p> <p>R- </p> <p>DF000381v01_nn.FH11</p>	<p>Sine (1 V_{pp})</p> <p>Without absolute value</p>	<p>Rotary motor:</p> <p>Increasing actual position values with clockwise motor motion (when viewed from the front toward the A-side shaft end)</p> <p>Linear Rexroth motor:</p> <p>Increasing actual position values with motor motion in the direction of cable outlet</p>
 <p>DK000090v01_nn.FH9</p>	<p>A+TTL </p> <p>A-TTL </p> <p>B+TTL </p> <p>B-TTL </p> <p>R+ </p> <p>R- </p> <p>DF000380v01_nn.FH11</p>	<p>Square-wave (TTL)</p> <p>Without absolute value</p>	
 <p>DK000088v01_nn.FH9</p>	<p>A+ </p> <p>A- </p> <p>B+ </p> <p>B- </p> <p>DF000382v01_nn.FH11</p>	<p>Sine (1 V_{pp})</p> <p>With absolute value (e.g., EnDat)</p>	
 <p>DK000365v01_nn.FH11</p> <p>Amplitude-modulated signal</p>	<p>A+ </p> <p>A- </p> <p>B+ </p> <p>B- </p> <p>DF000382v01_nn.FH11</p>	<p>Resolver</p>	

1) See following note
Tab. 8-7: Signal assignment to the actual position value

Technical data - functions



The encoder signal assignment to the inputs is based on clockwise rotation (front view toward motor shaft).

- Track A (A+, A-, "cos") advances track B (B+, B-, "sin") 90° electrically.
- The actual position value increases (prerequisite: negation of the encoder signals was not parameterized).
- If available, the reference track R (R+, R-) provides the reference mark pulse at positive signals of track A and track B (in the so-called "0-th" quadrant).



Standard setting: See Functional Description of firmware.

Technical data - functions

8.2 EM - encoder emulation

8.2.1 Cables

Data	Symbol	Unit	max.
Length (shielded cable)	l_{shield}	m	40
Length (unshielded cable)	l_{unshield}	m	30
Capacitance	C	pF/m	60

Tab. 8-8: Cables

8.2.2 Incremental encoder emulation

Connection

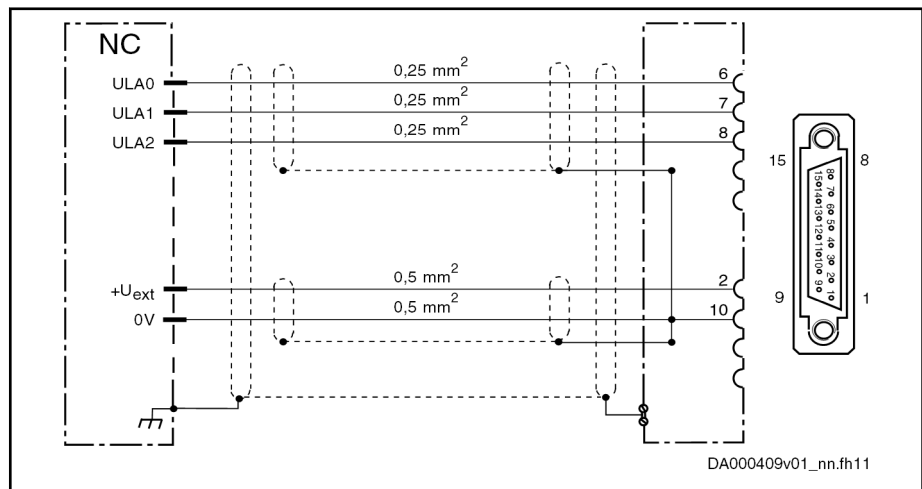

Fig. 8-22: Incremental encoder (single-ended)

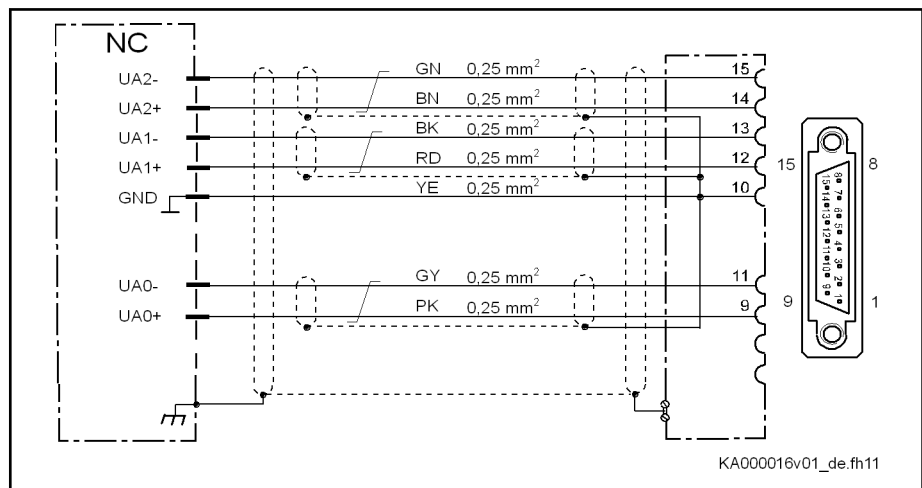

Fig. 8-23: Incremental encoder (RS422)

Electrical data

Single-ended

Data	Symbol	Unit	min.	typ.	max.
Input voltage	U_{ext}	V	5	-	30
Current consumption at U_{ext}	I_{ext}	mA	25	-	$25 + 3 \times I_{out}$
Output voltage "high"	U_{Out_High}	V	$U_{ext} - 2V$	-	U_{ext}
Output voltage "low"	U_{Out_Low}	V	-	-	1.5
Output current	I_{Out}	mA	-	-	40
Output frequency	f	MHz	-	1	-
Overload protection	-	-	Present		
Short circuit protection	-	-	Present		

Tab. 8-9: Single-ended

RS422

Data	Symbol	Unit	min.	typ.	max.
Output voltage "high"	U_{Out_High}	V	2.5	-	5
Output voltage "low"	U_{Out_Low}	V	0	-	0.5
Output current	I_{Out}	mA	-	-	20
Output frequency	f	MHz	-	4	-
Overload protection	-	-	Present		
Short circuit protection	-	-	Present		

Tab. 8-10: Outputs, RS422

Data	Symbol	Unit	min.	typ.	max.
Input voltage "high"	U_{In_High}	V	2.5	-	5
Input voltage "low"	U_{In_Low}	V	0	-	0.5
Input resistance (difference)	R_{In_D}	ohm	110	-	130
Input resistance	R_{In}	kOhm	-	150	-
Output frequency	f	MHz	-	4	-
Overload protection	-	-	Present		
Short circuit protection	-	-	Present		

Tab. 8-11: Inputs, RS422

Technical data - functions

8.2.3 Absolute encoder emulation (SSI format)

Connection

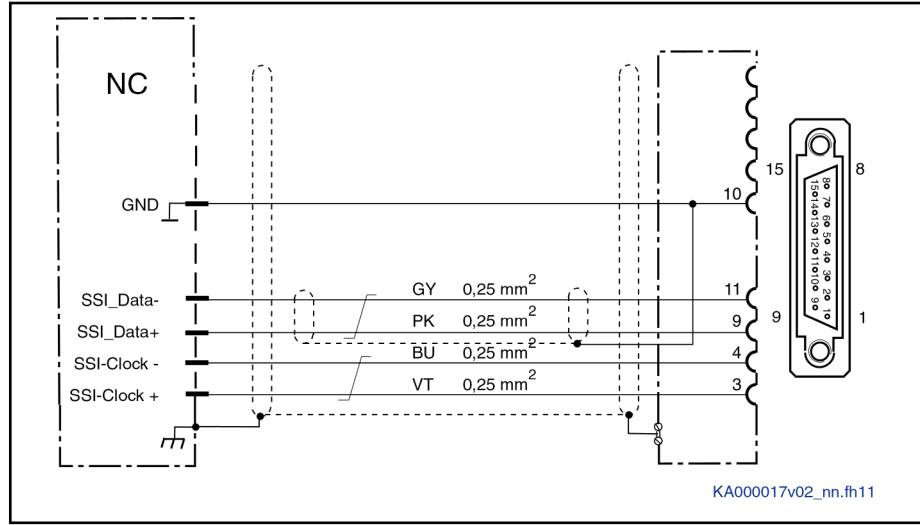

Fig. 8-24: Output of absolute actual position values according to SSI format

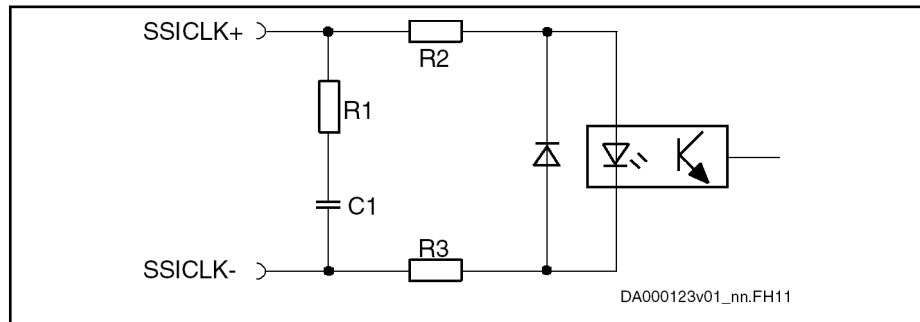

Fig. 8-25: Differential input circuit (block diagram)

Electrical data

Differential inputs, absolute encoder emulation

Data	Symbol	Unit	min.	typ.	max.
Input voltage "high"	U_{In_High}	V	2.5	-	5
Input voltage "low"	U_{In_Low}	V	0	-	0.5
Input resistance (difference)	R_{In_D}	ohm	110	-	130
Input resistance	R_{In}	kOhm	150		
Clock frequency	f	kHz	100–1000		
Overload protection	-	-	Present		
Short circuit protection	-	-	Present		

Tab. 8-12: Differential inputs

Differential outputs, absolute encoder emulation

Data	Symbol	Unit	min.	typ.	max.
Output voltage "high"	U_{Out_High}	V	2.5	-	5
Output voltage "low"	U_{Out_Low}	V	0	-	0.5

Technical data - functions

Data	Symbol	Unit	min.	typ.	max.
Output current	I_{Out}	mA	-	-	20
Output frequency	f	MHz	-	-	1
Load capacitance between output and 0 V		nF	-	-	10
Terminating resistor at load	R_{Term}	ohm	150–180		
Overload protection	-	-	Present		
Short circuit protection	-	-	Present		

Tab. 8-13: Differential outputs



The differential output corresponds to the RS422 specifications. On the control side, a line terminating resistor has to be available for the SSI data signal. If this resistor is not available, connect an external line terminating resistor (150-180 ohm).

Pulse diagram

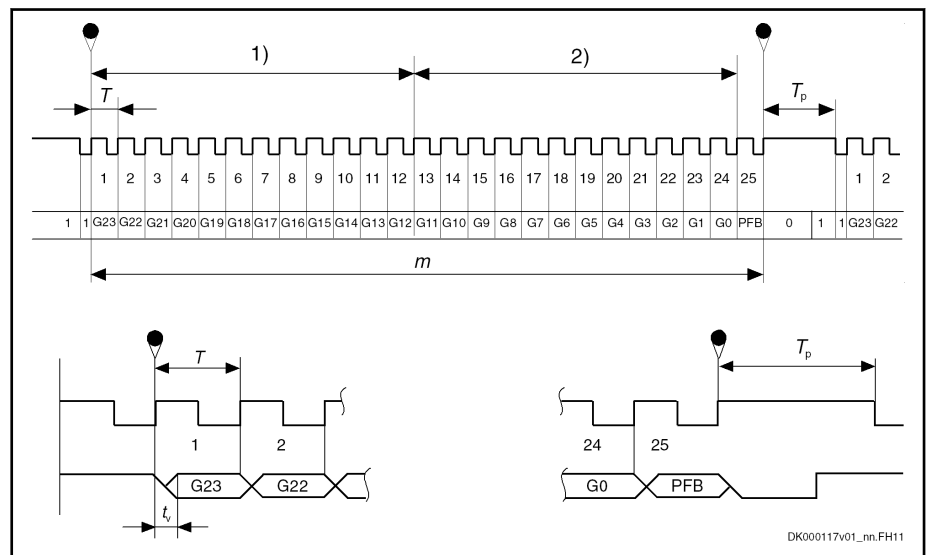



- 1) Resolution for 4096 revolutions
 - 2) Resolution for 1 revolution
 - G0 Least significant bit in Gray code
 - G23 Most significant bit in Gray code
 - m Stored parallel information
 - T Clock time
 - T_p Clock break $\geq 20 \mu s$
 - t_v Max. delay 200 ns
 - PFB Power failure bit (not used and always logically LOW)
- Fig. 8-26: Pulse diagram with absolute actual position value output (SSI format)

Technical data - functions

8.3 ET - Multi-Ethernet

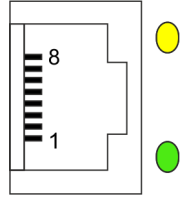
8.3.1 Display elements

LED	Significance
	Port LED, 1 × yellow, 1 × green
	Diagnostic LED, multicolor

Tab. 8-14: ET, display elements



The LED display depends on the field bus system.

- Port LED**
- [chapter "EtherNet/IP" on page 115](#)
 - [chapter "EtherCAT" on page 115](#)
 - [chapter "sercos III" on page 115](#)
 - [chapter "PROFINET IO" on page 116](#)

- Diagnostic LED**
- [chapter "EtherNet/IP" on page 117](#)
 - [chapter "EtherCAT" on page 118](#)
 - [chapter "sercos III" on page 119](#)
 - [chapter "PROFINET IO" on page 121](#)

8.3.2 Port LED



EtherNet/IP

LED: Color / flashing pattern	Significance
 Off	No connection No data transmission
 Permanently lit yellow	Data transmission running
 Permanently lit green	Connection to network available

Tab. 8-15: Port LED



EtherCAT

EtherCAT has only one active LED per port.

LED: Color / flashing pattern	Significance
 Off	No connection
 Permanently lit green	Connection to network available, but no telegram exchange (EtherCAT bus inactive)
 Flashing green	Connection to network available with telegram exchange (EtherCAT bus active)

Tab. 8-16: Port LED



sercos III

LED: Color / flashing pattern	Significance
 Off	No connection No data transmission
 Permanently lit yellow	Data transmission running
 Permanently lit green	Connection to network available

Tab. 8-17: Port LED

Technical data - functions







PROFINET IO

LED: Color / flashing pattern	Significance
 Off	No connection No data transmission
 Permanently lit yellow	Data transmission running
 Permanently lit green	Connection to network available

Tab. 8-18: Port LED

8.3.3 Diagnostic LED







EtherNet/IP

LED: Color / flashing pattern	Significance
 Off	The device does not have a valid IP address or has been switched off.
 Flashing green	The device has run up with a valid IP address, but does not have a cyclic connection.
 Permanently lit green	The I/O connection has been established without error.
 Flashing red	The existing I/O connection was unexpectedly aborted (e.g., watchdog).
 Permanently lit red	The "Duplicate-IP-Adress-Check" showed that the IP address which was set already exists in the network.
 Flashing red-green	The device is running up and carries out a self test.

Tab. 8-19: Diagnostic LED

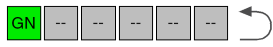
Technical data - functions

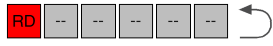
EtherCAT

LED: Color / flashing pattern ¹⁾	Significance	Description
 Off	Status INIT	<ul style="list-style-type: none"> Cyclic process data and acyclic data channel are not transmitted No error
 Flashing green	Status PRE-OPERATIONAL	Acyclic data channel is transmitted
 Green, one LED lighting up	Status SAFE-OPERATIONAL	Acyclic data channel is transmitted
 Permanently lit green	Status OPERATIONAL	Cyclic process data and acyclic data channel are transmitted
 Flashing red	Configuration error	General EtherCAT configuration error
 Red, one LED lighting up	Synchronization error	<ul style="list-style-type: none"> The drive controller has not been synchronized to the EtherCAT master Communication error of the drive controller
 Red, two LEDs lighting up	Timeout - watchdog	<ul style="list-style-type: none"> Timeout while cyclic process data are monitored Watchdog of the EtherCAT master



1) Flashing pattern: One square corresponds to a duration of 200 ms; the arrow marks the end of a cycle; abbreviations on the squares: GN = LED permanently lit green, RD = LED permanently lit red, -- = LED is off

Tab. 8-20: Diagnostic LED

sercos III

LED: Color / flashing pattern ¹⁾	Description	Prio ²⁾
 Off	NRT mode (no Sercos communication) ³⁾	6
 Permanently lit orange	CP0 (communication phase 0 active)	6
 Flashing orange-green	CP1 (communication phase 1 active)	6
 Flashing orange-green	CP2 (communication phase 2 active)	6
 Flashing orange-green	CP3 (communication phase 3 active)	6
 Permanently lit green	CP4 (communication phase 4 active)	6
 Flashing orange-green	HP0 (hot-plug phase 0 active)	6
 Flashing orange-green	HP1 (hot-plug phase 1 active)	6
 Flashing orange-green	HP2 (hot-plug phase 2 active)	6
 Flashing green	Transition from Fast forward to Loopback	5
 Flashing red-orange	Application error (sub-device/device error [C1D])	4
 Flashing red-green	MST warning ⁴⁾ (S-0-1045, Sercos: Device Status [S-Dev], bit15)	3
 Permanently lit red	Communication error (sub-device/device error [C1D])	2







Technical data - functions

LED: Color / flashing pattern ¹⁾	Description	Prio ²⁾
 Flashing orange	Identification (S-0-1044, Sercos: Device Control [C-Dev], bit15)	1
 Flashing red	Internal watchdog	0

- 1) Flashing pattern: One square corresponds to a duration of 250 ms; the arrow marks the end of a cycle; abbreviations on the squares: GN = LED permanently lit green, OG = LED permanently lit orange, RD = LED permanently lit red, -- = LED is off
- 2) Display priority (1 = highest priority); the state of the highest priority is displayed
- 3) NRT = None Real Time
- 4) MST = Master synchronization telegram

Tab. 8-21: Diagnostic LED

PROFINET IO

LED: Color / flashing pattern	Significance
 Off	The device does not have a valid IP address or has been switched off.
 Flashing green	The device has run up with a valid IP address, but does not have a cyclic connection.
 Permanently lit green	The I/O connection has been established without error.
 Flashing red	The existing I/O connection was unexpectedly aborted (e.g., watchdog).
 Permanently lit red	The "Duplicate-IP-Adress-Check" showed that the IP address which was set already exists in the network.
 Flashing red-green	The device is running up and carries out a self test.

Tab. 8-22: Diagnostic LED

Technical data - functions

8.4 PB - PROFIBUS

Signal specification

Signal	Specification
+5V Repeater supply	+5 V ($\pm 10\%$) Max. 75 mA
Repeater control signal	TTL-compatible: <ul style="list-style-type: none"> • 1: Transmit • 0: Receive Output resistance: 350R $V_{OL} \leq 0.8 \text{ V}$ at $I_{OL} \leq 2 \text{ mA}$ $V_{OH} \geq 3.5 \text{ V}$ at $I_{OH} \leq 1 \text{ mA}$
Receive/transmit data	EIA-RS485 standard

Tab. 8-23: Signal specification

NOTICE

**Danger of destroying output
"+5V repeater supply" by overload!**

Do not short-circuit the output.



Do not exceed the maximum current.

Diagnostic displays

For the significance of the diagnostic displays, see firmware documentation.

8.5 CN - CANopen

Display Elements CANopen

LED	Significance	Color	Description
H4	Run	 Green	Signals operating states; see Functional Description of firmware
H5	Error	 Red	Signals error states; see Functional Description of firmware

Tab. 8-24: Significance of Display Elements for CANopen

Main features

Feature	CANopen
Compatibility	According to EN 50325-4
Max. possible number of nodes	127 nodes
Bus topology	Line topology
Bus terminator (ISO 11898)	Terminating resistor of 120 ohm each at both bus ends
Transmission medium	2 twisted two-wire lines (4-pin) with shield
Max. allowed bus (line) lengths	Depending on bit rate
Recommended connection cable	Our RKS number or third-party type

Tab. 8-25: Main features

Bus lengths depending on bit rates

Bit rate [kBaud]	Max. allowed network dimension [m]
1000	25
800	50
500	100
250	250
125	500
50	1000
20	2500
10	5000

Tab. 8-26: Network dimension

Technical data - functions





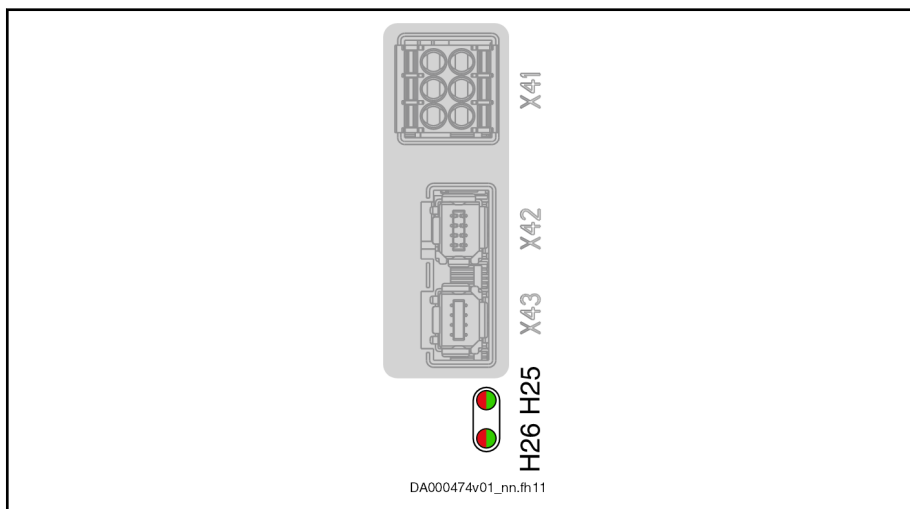



8.6 Sx - Safe Motion, Safe Motion Bus

8.6.1 Display elements



- H25** Bicolor LED: Safety technology status
H26 Bicolor LED: Connection status
X41, X42, X43 Not available for "Safe Motion Bus" option
Fig. 8-27: Safe Motion, display elements

Technical data - functions

Color / flashing pattern ¹⁾	Safety technology status ³⁾ (Safety Supervisor State / Event)	Connection status ³⁾
 Off	<ul style="list-style-type: none"> Not active Safety bus communication not configured 	<ul style="list-style-type: none"> Not ready Safety bus communication not configured
 Flashing green	Active, no connection (safety default)	Ready and no active connection
 Permanently lit green	Active, at least one safe connection	Ready and at least one active connection
 Flashing red-green	<ul style="list-style-type: none"> Waiting for TUNID ²⁾ Self test and initialization Identifying the axis identifier 	<ul style="list-style-type: none"> Waiting for TUNID ²⁾ Self test and initialization Identifying the axis identifier
 Flashing red-green	Identifying the safety technology	-
 Flashing red-green	TUNID ²⁾ not yet set	-
 Flashing red	Abortion of connections	Faulty abortion of at least one active connection
 Permanently lit red	Critical error	Critical connection error

- 1) Flashing pattern: One square corresponds to a duration of 250 ms; the arrow marks the end of a cycle; abbreviations on the squares: GN = LED permanently lit green, RD = LED permanently lit red, -- = LED is off
- 2) TUNID = Target Unique Network Identifier
- 3) The LED display is only active with safety bus communication via the master communication

Tab. 8-27: LED display

Technical data - functions

8.7 Digital inputs/outputs

8.7.1 General Information

The digital inputs/outputs correspond to "IEC 61131".



Do not operate digital outputs at low-resistance sources!

In the Functional Description of the firmware, observe the Notes on Commissioning for digital inputs/outputs.

8.7.2 Digital inputs

Digital inputs type A (standard)

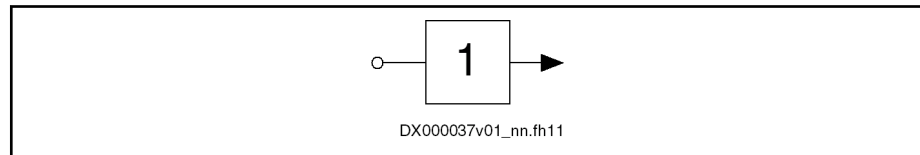

Fig. 8-28: Symbol

Data	Unit	Min.	Max.
Allowed input voltage	V	-3	30
High	V	15	30
Low	V	-3	5
Current consumption	mA	2	5
Control delay	μ s		1000 + position controller clock 200 + position controller clock ¹⁾

1) Applies to optional I/O extension DA

Tab. 8-28: Digital inputs type A

Digital inputs type B (probe)

Function See "Probe" in the Functional Description of the firmware.
Technical data

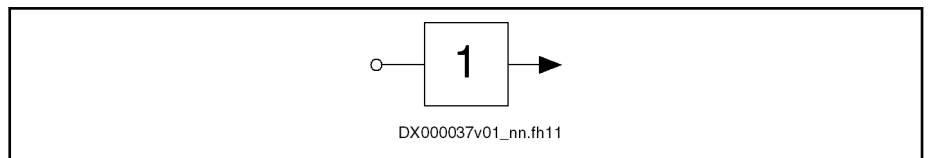
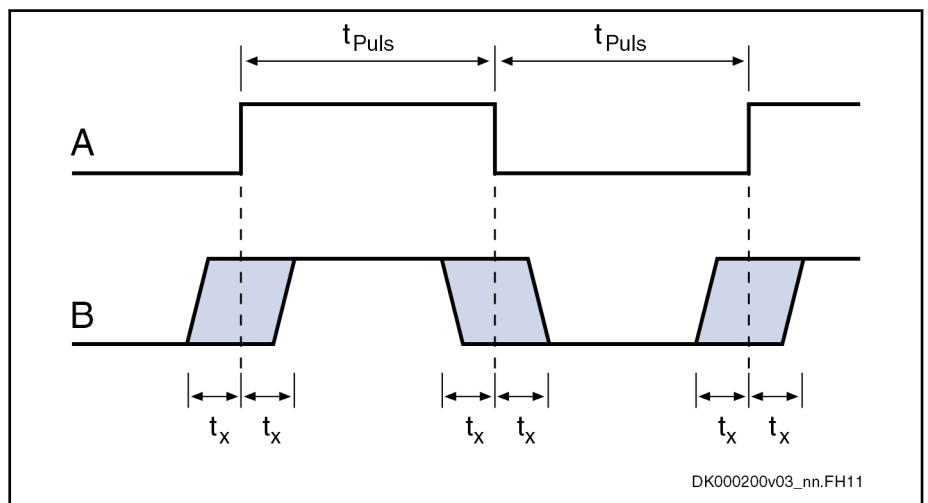

Fig. 8-29: Symbol

Data	Unit	min.	max.
Allowed input voltage	V	-3	30
High	V	15	30
Low	V	-3	5
Input current	mA	2	5
Pulse width t_{Puls}	μs	4	
Measuring accuracy t_x	μs	-1	1
Delay ¹⁾	μs		4 + position controller clock

1) Applies when used as a digital input. Does not apply when used as a probe.

Tab. 8-29: Digital inputs type B



A Signal
B Signal Detection at Probe Input
 t_{Puls} Pulse width
 t_x Measuring accuracy of the signal edges

Fig. 8-30: Signal Detection at Probe Input

Use To acquire fast digital input signals.



Probe inputs are "fast" inputs. For control use bounce-free switching elements (e.g. electronic switches) to avoid incorrect evaluation.

Technical data - functions

Digital inputs (safety technology L options)

The digital inputs correspond to IEC 61131, type 2.

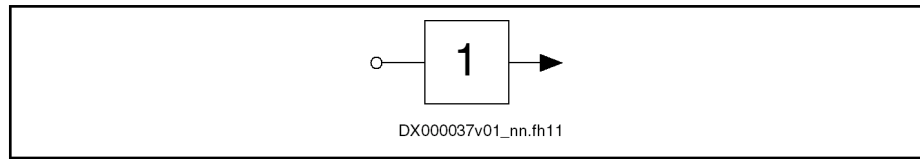

Fig. 8-31: Symbol

Data	Unit	Min.	Max.
Allowed input voltage	V	-3	30
High	V	11	30
Low	V	-3	5
Current consumption ¹⁾	mA	7	15

1) For KCU02, the specified values must be multiplied with the number of zone nodes of the drive line.

Tab. 8-30: Digital inputs (safety technology L options)

Digital inputs (safety technology S options)

The digital inputs correspond to IEC 61131, type 1.

Data	Unit	min.	max.
Allowed input voltage	V	-3	30
High	V	15	30
Low	V	-3	5
Current consumption	mA	2	5

Tab. 8-31: Digital inputs (safety technology S options)

Time behavior

Description	Unit	min.	max.
Test pulse width (t_{PL})	μs	0	1000
Percentage of High time ($T_{PH}/T_P \times 100\%$)	%	90	100
Phase shift between two test pulses on both channels (φ)	ms	-	-

DK000384v01_in.FH11

Tab. 8-32: Time behavior

Technical data - functions

8.7.3 Digital outputs

Digital outputs (standard)

The digital outputs are compatible with digital inputs of types 1, 2 and 3 (IEC 61131).

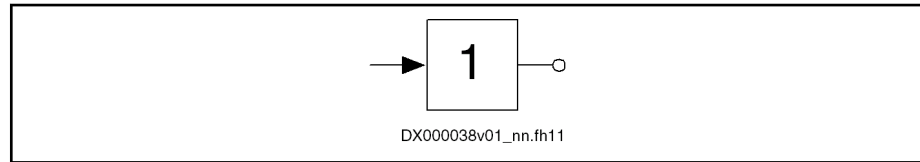

Fig. 8-32: Symbol

Data	Unit	Min.	Max.
Output voltage ON ¹⁾	V	$U_{\text{ext}} - 1$	U_{ext}
Output current OFF	mA		0,05
Output current ON	mA		500
Sum of output currents ²⁾	mA		<ul style="list-style-type: none"> ■ 4 outputs ■ 1000 ■ 8 outputs ■ 2000
Allowed energy content of connected inductive loads ^{3) 4)}	mJ		<ul style="list-style-type: none"> ■ $f < 0.5 \text{ Hz}$ ■ 500 ■ $f < 2 \text{ Hz}$ ■ 200
Control delay	μs		800 200 ⁵⁾
Short circuit protection		Present	
Overload protection		Present	

- 1) U_{ext} : Supply voltage
- 2) When several outputs supply current simultaneously, the maximum allowed total current of these outputs must be taken into account. According to the number of outputs, the total current must be related to 4 or 8 outputs.
- 3) In the case of inductive loads with a greater energy content, an external free-wheeling arm must be installed. The effective terminal voltage must be $< 25 \text{ V}$.
- 4) The maximum energy content depends on the switching frequency f of the outputs
- 5) Applies to optional I/O extension DA

Tab. 8-33: Digital outputs



- The digital outputs have been implemented with high-side switches. This means that these outputs only can actively supply current.
- The energy absorption capacity of the outputs is used to limit voltage peaks caused when inductive loads are switched off. Limit voltage peaks by using free-wheeling diodes directly at the relay coil.

Digital outputs (safety technology L options)

The digital outputs are compatible with digital inputs of types 1, 2 and 3 (IEC 61131).

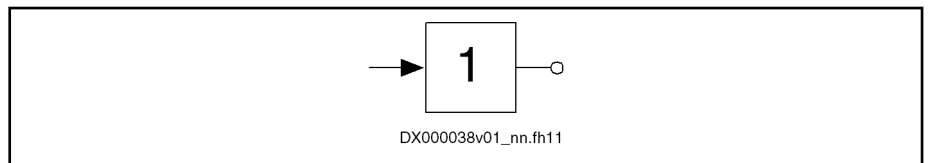

Fig. 8-33: Symbol

Data	Unit	Min.	Max.
Supply voltage (U_{ext})	V	19,2	30
Current consumption (I_{ext})	mA		700
Output voltage ON	V	18,2	30
Output voltage OFF	V		5
Output current ON	mA		350
Allowed energy content of connected inductive loads, e.g. relay coils; only allowed as single pulse	mJ		400
Short circuit protection		Available	
Overload protection		Available	

Tab. 8-34: Digital outputs (safety technology L options)

Technical data - functions

Digital outputs (safety technology S options)

The digital outputs are compatible with digital inputs of types 1, 2 and 3 (IEC 61131).

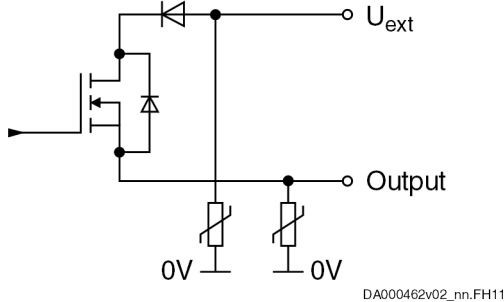
Data	Unit	min.	max.
Output voltage ON	V	$U_{\text{ext}} - 1$	U_{ext}
Output voltage OFF	V		2
Allowed output current per output	mA		350
Allowed energy content of connected inductive loads, e.g. relay coils	mJ		400 ^{1) 2)}
Capacitive load	nF		320
Short circuit protection		Present	
Overload protection		Present	
Block diagram output:			
Error detection	<p>The following errors are detected:</p> <ul style="list-style-type: none"> • Wiring error with short circuit to high • Wiring error with short circuit to low • Wiring error with short circuit between the two channels • Internal errors <p>In the case of an error, the control panel shows the corresponding error message: F83xx</p>		

1)

At a maximum switching frequency of 1 Hz

2)

In the case of inductive loads with currents > 200 mA or in the case of inductive loads with a greater energy content, an external free-wheeling arm has to be installed. The effective terminal voltage has to be < 25 V.

Tab. 8-35:

Digital outputs

Time behavior

Description	Unit	min.	max.
Test pulse width (t_{PL})	μs	100	200
Periodic time (T_P)	ms	500	1000
Phase shift between two test pulses on both channels (φ)	ms	50	-

DK000956v01_m.FH11

Tab. 8-36: Time behavior

Technical data - functions

8.8 Analog voltage input

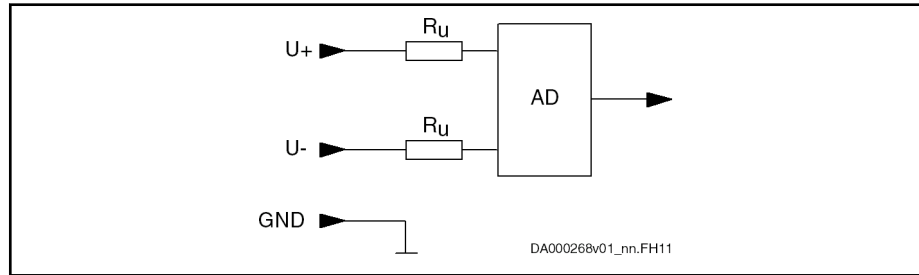

AD Analog/digital converter

Fig. 8-34: Analog voltage input

Data	Unit	Min.	Typ.	Max.
Allowed input voltage	V	-30		+30
Working range input voltage U_{on_work}	V	-10		+10
Input resistance R_u	k Ω	150		300
Input bandwidth (-3 dB)	kHz		1,3	
Common-mode range	V	-30		+30
Common-mode rejection	dB	50		
Relative measuring error at 90% U_{on_work}	%	-1		+1
Resolution	Bit		14 ¹⁾ 13 ²⁾	
Cables		For cable lengths > 30 m, only use shielded cables.		

1) Applies to: Cxx02 control sections (X32), optional I/O extension DA (X38), HCS01 drive controllers (X32)

2) Applies to: Control sections with extended scope CSx02.1B (X35), CDB02.1B (X36)

Tab. 8-37: Analog voltage input

8.9 Analog current input

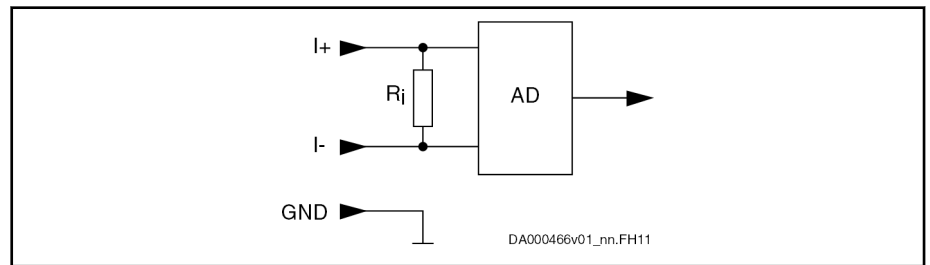

AD Analog/digital converter

Fig. 8-35: Analog current input

Electrical data (current inputs [-20/4 ... 20 mA])

Spring terminal (connector)	Unit	min.	max.
Input current measuring range ¹⁾	mA	-20 / 4	20
Input current minimum value monitoring ²⁾	mA	2	3
Input current maximum value monitoring ³⁾	mA	21	22
Input resistance	Ω	280	
Input bandwidth (-3db)	kHz	1.3	
Relative measuring error at 18 mA	%	-1	+1
Resolution	-	13bit (12bit + 4-fold oversampling) ⁵⁾ 12bit (11bit + 4-fold oversampling) ⁶⁾	
Overload protection ⁴⁾	-	Present	
Wiring	-	Only use shielded cables for cable lengths > 30 m.	

- 1) Measuring range (-20 ... 20 or 4 ... 20) can be set using a parameter. With a measuring range 4 ... 20, the minimum value monitoring (wire break) is automatically active.
- 2) Only possible with a measuring range 4 ... 20
- 3) Monitoring switched off at approx. ±35 mA
- 4) In the case of input currents greater than the maximum value, an error is signaled and the input is switched at high resistance
- 5) Applies to: Optional I/O extension DA (X38)
- 6) Applies to: Control sections with extended scope CSx02.1B (X35), CDB02.1B (X36)

Tab. 8-38: Electrical data

Technical data - functions

8.10 Analog output

Data	Unit	min	Typ.	max
Output voltage	V	-10		+10
Output load, ohmic	k Ω	2		
Output load, capacitive	nF			100
Resolution	mV/incr	6 ²⁾		
Conversion time (incl. response time)	μ s			750 250 ¹⁾
Output clock		Position controller clock		
Precision (in relation to the measuring range)		$\pm 0.5\%$ with load ≥ 10 k Ω $\pm 1\%$ with load ≥ 2 k Ω		
Short circuit protection		Present		
Overload protection		Present		

- 1) Applies to optional I/O extension DA
 2) Valid with index AH1 and above of the ICI04 circuit board and/or with production week 15W39 and above of the control section (see control section type plate). Previously, the resolution was 24 mV/incr.

Tab. 8-39: Analog outputs

8.11 Relay Contacts

8.11.1 Relay Contact Type 2

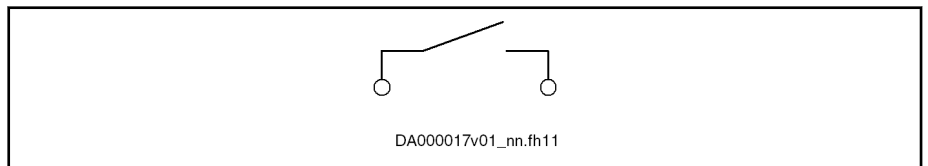

Fig. 8-36: Relay contact

Data	Unit	Min.	Typ.	Max.
Current carrying capacity	mA	10		1000
Voltage load capacity	V			30
Contact resistance at minimum current	mΩ			1000
Switching actions at max. time constant of load			1×10^6	
Number of mechanical switching cycles			1×10^8	
Time constant of load	ms	ohmic		
Pick up delay	ms			10
Drop out delay	ms			10

Tab. 8-40: Relay Contacts Type 2

9 Technical data - other

9.1 Power consumption

9.1.1 General information

The power consumption of the control sections consists of the following components:

- Basic equipment
- Optional equipment



The control sections are supplied via the terminal connectors 24V and 0V at the power section (24V supply).

9.1.2 Basic circuit boards of control section



According to the options with which the configurable control sections have been equipped, the power consumption of the optional modules has to be added. This does not change the data for inrush current and pulse width.

The power consumption is specified as the maximum value of the respective component and can occur at individual components. In drive systems with multiple components, the occurring power consumption under statistical assumptions will be lower than the calculated one.

Control section	Power consumption P_{N3} at $U_{N3} = DC\ 24\ V$ [W]	Max. inrush current I_{EIN3} [A]	Max. pulse width $t_{EIN3Lade}$ [ms]
CSE02.1A	12 ¹⁾	< 5	1
CSB02.1A	17 ¹⁾		
CSB02.xB	17 ¹⁾		
CDB02.1B	23 ^{2) 3)}		
CSH02.1B	17 ^{2) 3)}		

- 1) Incl. "EC" encoder interface, corresponding communication and control panel
 2) Incl. control panel and "PFM" memory card
 3) At maximum allowed output load, plus power consumption of optional modules

Tab. 9-1: Power consumption of control sections



The isolated inputs/outputs at X31, X35 and X36 are not supplied via the connections of the 24V supply of the power section. A separate power supply is required for these inputs/outputs.

Technical data - other

9.1.3 Optional modules

Option ¹⁾	Optional module	Power consumption P_{N3} ²⁾ [W]
CN	CANopen communication	1.5
DA	I/O extension digital/analog	0.6
EC	Multi-encoder systems	1.1
EM	Emulation of absolute and incremental encoders	1.2
EP	Engineering port	< 0.3
ET	Multi-Ethernet	2.7
L3	Safe Torque Off	1.0
PB	PROFIBUS-DP communication	1.1
S4	Safe Motion	2.5
S5	Safe Motion	2.5
SB	Safe Motion Bus	2.5

1) See type codes of the control sections

2) At maximum allowed output load, plus circuits to be supplied externally

Tab. 9-2: *Power consumption of optional modules*

9.2 Connection points

9.2.1 General information

The connection points at control sections are equipped with spring terminals and screw terminal blocks.



To connect 2 conductors in one terminal connecting point:

- Use stranded wires with min. 0.5 mm² and max. 1.0 mm²
 - Use wires of the same cross section
 - Use TWIN ferrules
-

9.2.2 Connection points with spring terminals

Spring terminals can be wired with wire ends equipped **with or without ferrules**. Preferably use wire ends without ferrules.

When assembling the connections, make sure

- that the stripped length of the wire ends is 10 mm
- that all strands of a stranded wire are placed in the funnel of the terminal connector
- not to use solid wires, where possible
- to use appropriate crimping tools for the wire ends with ferrules

9.2.3 Connection points with screw terminal blocks

On screw terminal blocks, use wire ends **with** ferrules. Make sure to use appropriate crimping tools.

When assembling the connections, make sure that all strands of a stranded wire are placed in the funnel of the terminal connector.

Technical data - other

9.3 Analog inputs/outputs: Shield connection

9.3.1 Analog input

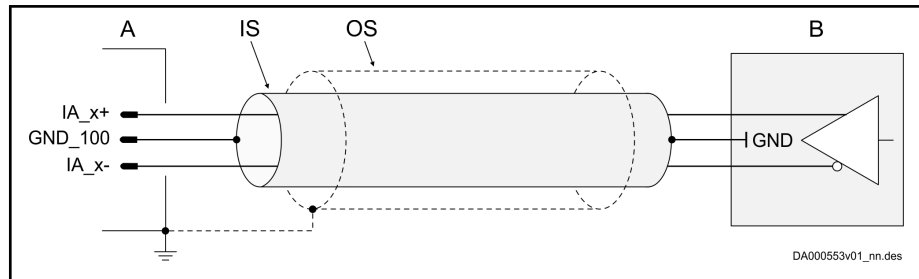

A Analog input of the drive controller; **only connect the inner shield of the connection cable to the drive controller if GND has not been connected to ground in the external device.**

B External device

IS Inner shield of the connection cable

OS Overall shield of the connection cable

Fig. 9-1: Shield connection for analog inputs

9.3.2 Analog output

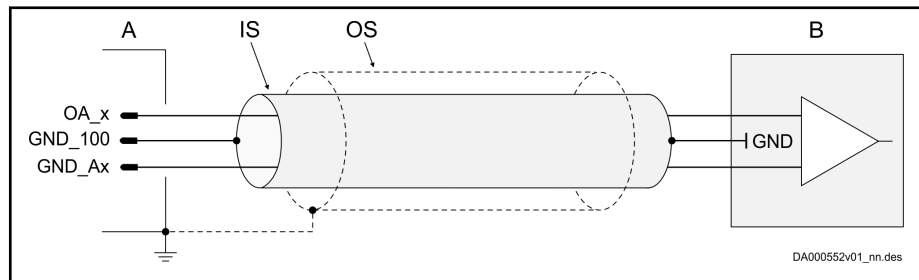

A Analog output of drive controller

B External device; **only connect the inner shield of the connection cable to the external device if GND has not been connected to ground in the external device.**

IS Inner shield of the connection cable

OS Overall shield of the connection cable

Fig. 9-2: Shield connection for analog outputs

10 Accessories

There are the following accessories for control sections:

- **HSZ01** safety zone module

With the HSZ01 safety zone module it is possible to set up a safety zone with a maximum of 26 drive units.

- **HAT02** control module for inductive loads

HAT02 control module is used to safely control an inductive load, such as a self-applying motor holding brake, hydraulic/pneumatic valve, contactor.

11 Environmental protection and disposal

11.1 Environmental protection

Production processes	The products are manufactured in energy- and resource-optimized production processes which allow re-using and recycling the resulting waste. We regularly try to replace pollutant-loaded raw materials and supplies by more environment-friendly alternatives.														
No release of hazardous substances	Our products do not contain any hazardous substances which may be released in case of appropriate use. Normally, our products will not have any negative influences on the environment.														
Significant components	Significant components of our products are: <table><tr><td>Electronic devices</td><td>Motors</td></tr><tr><td>• Steel</td><td>• Steel / Stainless steel</td></tr><tr><td>• Aluminum</td><td>• Aluminum</td></tr><tr><td>• Copper</td><td>• Copper</td></tr><tr><td>• Plastics</td><td>• Brass</td></tr><tr><td>• Electronic components</td><td>• Magnetic materials</td></tr><tr><td></td><td>• Elektronic components</td></tr></table>	Electronic devices	Motors	• Steel	• Steel / Stainless steel	• Aluminum	• Aluminum	• Copper	• Copper	• Plastics	• Brass	• Electronic components	• Magnetic materials		• Elektronic components
Electronic devices	Motors														
• Steel	• Steel / Stainless steel														
• Aluminum	• Aluminum														
• Copper	• Copper														
• Plastics	• Brass														
• Electronic components	• Magnetic materials														
	• Elektronic components														

11.2 Disposal

Return of products	Our products can be returned to us for disposal free of charge. However, this requires that the products be free from oil, grease or other dirt. Furthermore, the products returned for disposal may not contain any undue foreign material or foreign components. Deliver the products "free domicile" to the following address: <p style="text-align: center;">Bosch Rexroth AG Electric Drives and Controls Buergermeister-Dr.-Nebel-Straße 2 97816 Lohr am Main, Germany</p>
Packaging	Packaging materials consist of cardboard, wood and polystyrene They can be recycled anywhere without any problem. For ecological reasons, please refrain from returning the empty packages to us.
Batteries and accumulators	Batteries and accumulators can be labeled with this symbol.  The symbol indicating "separate collection" for all batteries and accumulators is the crossed-out wheeled bin. End users in the EU are legally bound to return used batteries and accumulators. Outside the validity of the EU Directive 2006/66/EC, the particularly applicable regulations must be followed. Batteries and accumulators can contain hazardous substances which can harm the environment or people's health when improperly stored or disposed of. After use, the batteries or accumulators contained in Rexroth products must be properly disposed of according to the country-specific collection systems.

Environmental protection and disposal

- Recycling** Most of the products can be recycled due to their high content of metal. In order to recycle the metal in the best possible way, the products must be disassembled into individual assemblies.
- Metals contained in electric and electronic assemblies can also be recycled by means of special separation processes.
- Plastic parts of the products may contain flame retardants. These plastic parts are labeled according to EN ISO 1043. They have to be recycled separately or disposed of according to the applicable legal provisions.

12 Service and support

Our worldwide service network provides an optimized and efficient support. Our experts offer you advice and assistance should you have any queries. You can contact us **24/7**.

Service Germany Our technology-oriented Competence Center in Lohr, Germany, is responsible for all your service-related queries for electric drive and controls.

Contact the **Service Hotline** and **Service Helpdesk** under:

Phone: **+49 9352 40 5060**
Fax: **+49 9352 18 4941**
E-mail: service.svc@boschrexroth.de
Internet: <http://www.boschrexroth.com>

Additional information on service, repair (e.g. delivery addresses) and training can be found on our internet sites.

Service worldwide Outside Germany, please contact your local service office first. For hotline numbers, refer to the sales office addresses on the internet.

Preparing information To be able to help you more quickly and efficiently, please have the following information ready:

- Detailed description of malfunction and circumstances
- Type plate specifications of the affected products, in particular type codes and serial numbers
- Your contact data (phone and fax number as well as your e-mail address)

Index

0 ... 9

1Vpp	
Encoder, 5 V supply voltage.....	93
Encoder, 12 V supply voltage.....	94

A

Accessories	
Control section.....	143
Accumulators.....	145
ACURO@link (MS2N encoder interface).....	88
Additional documentations.....	8
ADVANCED	
Control panel.....	82
Control section.....	43
CSH02, overview - connection points.....	47

Analog input

Connection point X32.....	57
Connection point X32.1, X32.2.....	58
Connection point X35.....	60
Connection point X38.....	74
Current, technical data.....	135
Shield connection.....	142

Analog inputs

Voltage, technical data.....	134
------------------------------	-----

Analog output

Connection point X35.....	60
Connection point X36.....	61
Connection point X38.....	74
Shield connection.....	142
Technical data.....	136

B

BASIC

CDB02, overview - connection points.....	42
CDB02, type code.....	40
CSB02, overview - connection points.....	39
CSB02.1, type code.....	35
CSB02.5, type code.....	37

Batteries.....

	145
--	-----

Bb relay

X33.....	59
----------	----

Bb relay contact

Technical data.....	137
---------------------	-----

C

Cables

Documentation.....	8
RG2-002AA.....	88
RG2-002AB.....	88
RKB0013.....	53, 54
RKB0021.....	53, 54
RKB0061.....	76
RKB0062.....	76
RKG0033.....	86
RKG0035.....	93

RKG0036.....	91
RKG0062.....	86
RKG4200.....	87

CANopen

Bus length.....	123
Connection point X61.....	80
Display elements.....	123
Main features.....	123
Network dimension.....	123

CC

sercos III master.....	52
------------------------	----

CDB02

Overview - connection points.....	42
Type code.....	40

CN

CANopen.....	80
--------------	----

Combined encoder for SSI

Encoder, 5 V supply voltage.....	99
----------------------------------	----

Communication module

CANopen - CN.....	80
Multi-Ethernet - ET.....	52, 68
PROFIBUS PB, interface.....	70
PROFIBUS PB, signal specification.....	122
sercos III master.....	52
sercos III slave.....	52

Component marking.....

	25
--	----

Components

Documentations.....	8
---------------------	---

Configurability.....

	30
--	----

Connection

Analog input (X32.1, X32.2).....	58
Analog input (X32).....	57
Analog inputs/outputs (X38).....	74
Digital and analog inputs/outputs (X35).....	60
Digital inputs, digital output (X31 (double-axis)).....	56
Digital inputs, digital output (X31 (single-axis)).....	55
Digital inputs/outputs (X37).....	73
Digital inputs/outputs, analog outputs (X36).....	61
Encoder emulation (X8, X10).....	66
Motor encoder (X4.1, X4.2).....	51
Motor encoder (X4).....	50
On-board connection points.....	49
Optional connection points.....	63
Optional encoder evaluation (X8, X10).....	65
Probe.....	55, 56
PROFIBUS (X30).....	70
Shield connection, analog input.....	142
Shield connection, analog output.....	142

Connection points

On-board, overview.....	49
Optional, overview.....	63
See also "Connection".....	49

Index

With screw terminal blocks, notes.....	141		
With spring terminals, notes.....	141		
Contained substances			
see "Significant components".....	145		
Control panel			
ADVANCED control panel.....	82		
HAP01.1A.....	82		
HAP01.1N.....	83		
Standard control panel.....	83		
Type code.....	81		
Type plate.....	27		
Control section			
Accessories.....	143		
ADVANCED.....	43		
BASIC double-axis CDB02.....	40		
BASIC single-axis CSB02.....	35		
Configurability.....	30		
Delivery.....	11		
Dimensions.....	32		
ECONOMY.....	33		
Firmware.....	29		
Mounting and dismounting.....	11		
Optional modules.....	63		
Overview - functions and interfaces.....	30		
Overview - types.....	29		
Power consumption.....	139		
Power dissipation.....	139		
Type code ADVANCED CSH02.1.....	43		
Type code ADVANCED CSH02.5.....	45		
Type code BASIC double-axis.....	40		
Type code BASIC single-axis.....	35, 37		
Type code, ECONOMY.....	33		
Type plate.....	26		
CSB02			
Overview - connection points.....	39		
CSB02.1			
Type code.....	35		
CSB02.5			
Type code.....	37		
CSE02			
Overview - connection points.....	34		
Type code.....	33		
CSH02			
Overview - connection points.....	47		
CSH02.1			
Type code.....	43		
CSH02.5			
Type code.....	45		
D			
DA			
Optional module, analog/digital I/O extension.....	73, 74		
Data			
see "Technical data".....	85		
Delivery			
Control section.....	11		
Digital inputs			
Connection point X31 (double-axis).....	56		
Connection point X31 (single-axis).....	55		
Connection point X35.....	60		
Connection point X36.....	61		
Connection point X37.....	73		
Probe.....	55, 56		
Technical data, safety technology L options.....	128		
Technical data, safety technology S options.....	129		
Technical data, type A (standard input).....	126		
Technical data, type B (probe).....	127		
Digital outputs			
Connection point X31 (double-axis).....	56		
Connection point X31 (single-axis).....	55		
Connection point X35.....	60		
Connection point X36.....	61		
Connection point X37.....	73		
Technical data, safety technology L options.....	131		
Technical data, safety technology S options.....	132		
Technical data, standard output.....	130		
Dimensional drawing			
Control section.....	32		
Dimensions			
Control section.....	32		
Dismounting			
Control section.....	11		
Display elements			
Multi-Ethernet, LEDs.....	114		
Disposal.....	145		
Documentation			
Cables.....	8		
Changes.....	7		
Drive systems.....	8		
Editions.....	7		
Firmware.....	9		
Motors.....	8		
Overview.....	8		
Reference documentations.....	8		
System components.....	8		
Drive controller			
Control section.....	11		
Design.....	11		
Power section.....	11		
Type plates.....	25		
Drive system.....	15		
E			
EC			
Standard encoder evaluation.....	85		
ECONOMY			
CSE02.....	33		
Editions			
Documentation.....	7		

Electric drive system.....	15	EtherCAT	
EM		Multi-Ethernet, interface.....	52
Encoder emulation.....	66	F	
Encoder emulation, data.....	110	Firmware	
Emulated encoder systems.....	66	Documentation.....	9
Encoder		Supported firmware.....	29
1Vpp, 5 V supply voltage.....	93	Type plate.....	26
1Vpp, 12 V supply voltage.....	94	Functions and interfaces	
5 V power supply.....	102	Overview.....	30
12 V power supply.....	102	H	
ACURO@link.....	88	H4, H5	
Cable length.....	104	LED (CANopen).....	123
Combined encoder for SSI, 5 V supply		H25, H26	
voltage.....	99	LED (Safe Motion).....	124
Connection, X4.....	50	Hall sensor box	
Connection, X4.1, X4.2.....	51	SHL02.1.....	101
Connection, X8, X10, encoder emulation.....	66	HAP01	
EC, standard encoder evaluation.....	85	Type code.....	81
Emulated encoder systems.....	66	HAP01.1A	
EnDat 2.1, 5 V supply voltage.....	91	Control panel.....	82
EnDat 2.2, 5 V supply voltage.....	92	HAP01.1N	
HIPERFACE® (MS2N encoder interface).....	88	Control panel.....	83
HIPERFACE®, 12 V supply voltage.....	90	Hazardous substances.....	145
Input circuit, resolver.....	106	Helpdesk.....	147
Input circuit, sine signals.....	106	HIPERFACE®.....	90
Input circuit, square-wave signals.....	106	HIPERFACE® (MS2N encoder interface).....	88
MS2N encoder interface.....	88	Hotline.....	147
MSK/QSK encoder interface.....	87	I	
MSM, 5V supply voltage.....	86	Identification	
Optional encoder evaluation, X8, X10.....	65	Control section.....	25
Power supply.....	102	Input	
Resolver encoder system without encod-		Analog, X32.....	57
er data memory.....	100	Analog, X32.1, X32.2.....	58
Resolver power supply.....	103	Digital, X31 (double-axis).....	56
Signal assignment to actual position val-		Digital, X31 (single-axis).....	55
ue.....	108	Probe.....	55, 56
SSI, 5 V supply voltage.....	97	Intended use.....	13
SSI, 12 V supply voltage.....	98	Applications.....	13
Standard encoder evaluation EC.....	85	Interfaces	
Supported encoder systems.....	50, 85	Overview.....	30
TTL, 5 V supply voltage.....	95	L	
TTL, 12 V supply voltage.....	96	L3	
Encoder cable length.....	104	Safe Torque Off.....	79
Encoder emulation		LED	
EM.....	66	Communication.....	114
EM, data.....	110	Diagnostic LED, EtherCAT.....	118
EnDat 2.1		Diagnostic LED, EtherNet/IP.....	117
Encoder, 5 V supply voltage.....	91	Diagnostic LED, PROFINET IO.....	121
EnDat 2.2		Diagnostic LED, sercos III.....	119
Encoder, 5 V supply voltage.....	92	H4, H5 (CANopen).....	123
Engineering interface		H25, H26 (Safe Motion).....	124
X26.....	54	Multi-Ethernet.....	114
Environmental protection.....	145	Port LED, EtherCAT.....	115
EP			
Engineering interface.....	54		
ET			
Multi-Ethernet, connection point.....	52		
Multi-Ethernet, LEDs.....	114		

Index

Port LED, EtherNet/IP.....	115	BASIC single-axis CSB02.....	39
Port LED, PROFINET IO.....	116	ECONOMY CSE02.....	34
Port LED, sercos III.....	115		
M		P	
microSD memory card		P1, P2	
ADVANCED control panel.....	82	Communication.....	52
Motor		Packaging.....	145
Connection, motor encoder (X4).....	50	PB	
Documentation.....	8	Optional module, interface.....	70
Motor encoder connection (X4.1, X4.2).....	51	Optional module, signal specification.....	122
Mounting		PELV.....	20
Control section.....	11	Port LED	
MS2N encoder interface		Displays.....	115
for AS/AM, BS/BM, CS/CM, HS/HM,		Power consumption	
DS/DM encoder systems.....	88	Basic circuit board of control section.....	139
MSK/QSK encoder interface		Optional modules.....	140
For S1/M1, S2/M2, S3/M3, S5/M5 encod-		Power dissipation	
er systems.....	87	Basic circuit board of control section.....	139
MSM		Control section.....	139
Encoder, 5V supply voltage.....	86	Optional modules.....	140
Multi-Ethernet		Probe	
Display elements (LEDs).....	114	Technical data.....	127
ET.....	52	Probe input (X31 (double-axis)).....	56
Optional.....	68	Probe input (X31 (single-axis)).....	55
X24 P2, X25 P1.....	52	Production processes.....	145
O		PROFIBUS	
Optional module		Interface.....	70
CN, CANopen.....	80	Signal specification.....	122
DA, analog/digital I/O extension.....	73, 74	PROFINET	
DA, inputs/outputs (overview).....	31	Multi-Ethernet, interface.....	52
EC, encoder evaluation.....	65	Project Planning Manuals.....	8
EC, standard encoder evaluation.....	85	Protective extra-low voltage.....	20
EM, encoder emulation.....	66		
EP, Engineering interface.....	69	R	
ET, Multi-Ethernet.....	68	Recycling.....	146
L3, Safe Torque Off.....	79	Reference documentations.....	8
Overview.....	63	Relay	
PB, PROFIBUS, interface.....	70	Bb relay, X33.....	59
PB, PROFIBUS, signal specification.....	122	Relay contact	
S, standard control panel.....	83	Technical data.....	137
S4, Safe Motion.....	75	Type 2.....	137
S5.....	63	Resolver	
S5, Safe Motion.....	75	Encoder, input circuit.....	106
SB, Safe Motion Bus.....	63	Resolvers	
Optional modules		Encoder system without encoder data	
Power consumption.....	140	memory.....	100
Output, analog		Return of products.....	145
X35 (single-axis).....	60	RG2-002AA.....	88
X36 (double-axis).....	61	RG2-002AB.....	88
Output, digital		RKB0013.....	53, 54
X31 (double-axis).....	56	RKB0021.....	53, 54
X31 (single-axis).....	55	RKB0061.....	76
Overview - connection points		RKB0062.....	76
ADVANCED CSH02.....	47	RKG0033.....	86
BASIC double-axis CDB02.....	42	RKG0035.....	93
		RKG0036.....	91
		RKG0062.....	86

RKG4200.....	87
S	
S	
Optional module, standard control panel.....	83
S4	
Safe Motion.....	75
S5	
Safe Motion.....	63, 75
Safe Motion	
LEDs (H25, H26).....	124
S4.....	75
S5.....	63, 75
X41.....	75
X41.1, X41.2.....	75
Safe Motion Bus	
LEDs (H25, H26).....	124
SB.....	63
Safe Torque Off	
L3.....	79
X49.....	79
X49.1, X49.2.....	79
Safety instructions for electric drives and controls.....	15
Safety technology	
L3 (Safe Torque Off).....	79
S4 (Safe Motion).....	75
S5 (Safe Motion).....	75
SB	
Safe Motion Bus.....	63
Screw terminal blocks	
Notes.....	141
sercos III	
Optional.....	68
sercos III master	
CC.....	52
sercos III slave	
S3.....	52
Service hotline.....	147
Shield connection	
Analog input.....	142
Analog output.....	142
SHL02.1	
Hall sensor box.....	101
Significant components.....	145
Sine signals	
Encoder, input circuit.....	106
Spring terminals	
Connection points, notes.....	141
Square-wave signals	
Encoder, input circuit.....	106
SSI	
Encoder, 5 V supply voltage.....	97
Encoder, 12 V supply voltage.....	98
Standard control panel.....	83
Standard encoder evaluation EC.....	85
State-of-the-art.....	13

Support.....	147
T	
Technical data	
Analog input, current.....	135
Analog inputs, voltage.....	134
Analog output.....	136
Digital inputs, safety technology L options.....	128
Digital inputs, safety technology S options.....	129
Digital inputs, type A (standard input).....	126
Digital inputs, type B (probe).....	127
Digital outputs, safety technology L options.....	131
Digital outputs, safety technology S options.....	132
Digital outputs, standard output.....	130
Dimensions.....	32
Functions.....	85
Power dissipation.....	139
Relay contact.....	137
TTL	
Encoder, 5 V supply voltage.....	95
Encoder, 12 V supply voltage.....	96
Type code	
ADVANCED CSH02.1.....	43
ADVANCED CSH02.5.....	45
BASIC CDB02 double-axis.....	40
BASIC CSB02.1 single-axis.....	35
BASIC CSB02.5 single-axis.....	37
CDB02.....	40
Control panel.....	81
CSB02.1.....	35
CSB02.5.....	37
CSE02.....	33
CSH02.1.....	43
CSH02.5.....	45
ECONOMY CSE02.....	33
HAP01.....	81
Type plate	
At the drive controller.....	25
Control panel.....	27
Control section.....	26
Firmware.....	26
U	
Unintended use.....	14
Consequences, exclusion of liability.....	13
Use	
Intended use.....	13
Unintended use.....	14
X	
X4	
Motor encoder.....	50
X4.1, X4.2	

Index

Motor encoder.....	51
X8	
Encoder emulation.....	66
X8, X10	
Optional encoder evaluation.....	65
X22 P2, X23 P1	
Multi-Ethernet.....	68
X24 P2, X25 P1	
Communication.....	52
X26	
Engineering interface.....	54
X30	
PROFIBUS PB.....	70
X31 (double-axis)	
Digital inputs, digital output.....	56
X31 (single-axis)	
Digital inputs, digital output.....	55
X32	
Analog input.....	57
X32.1, X32.2	
Analog input.....	58
X33	
Power supply of digital I/Os, Bb relay.....	59
X35	
Digital and analog inputs/outputs.....	60
X36	
Digital inputs/outputs, analog outputs.....	61
X37	
Digital inputs/outputs.....	73
X38	
Analog inputs/outputs.....	74
X41	
Optional safety technology Safe Motion.....	75
X41.1, X41.2	
Optional safety technology Safe Motion.....	75
X42, X43	
Optional safety technology Safe Motion (communication).....	76
X42.1, X42.2, X43.1, X43.2	
Optional safety technology Safe Motion (communication).....	77
X48	
Safety technology SBC.....	78
X48.1, X48.2	
Safety technology SBC.....	78
X49	
Safe Torque Off.....	79
X49.1, X49.2	
Safe Torque Off.....	79
X61	
CANopen.....	80

Notes

Bosch Rexroth AG

Electric Drives and Controls

P.O. Box 13 57

97803 Lohr, Germany

Bgm.-Dr.-Nebel-Str. 2

97816 Lohr, Germany

Phone +49 9352 18 0

Fax +49 9352 18 8400

www.boschrexroth.com/electrics



R911338962